



9800 Martel Road

Lenoir City, TN 37772

www.ps-engineering.com

PMA8000B



Document P/N 200-890-0100

For serial numbers X04822 and below

Rev. 13, December 2009

Audio Selector Panel with Marker Beacon Receiver
High-fidelity Stereo Intercom
System Installation and Operation Manual
FAA- TSO C50c, C35d
EASA ETSO C50c, 2C35d
Patented under one or more of the following;
No. 4,941,187; 5,903,227; 6,160,496 and 6,493,450

**In certified aircraft, warranty is not valid unless this product is installed by an
Authorized PS Engineering dealer.**

PS Engineering, Inc. 2009 ©

Copyright Notice

Any reproduction or retransmittal of this publication, or any portion thereof, without the expressed written permission of PS Engineering, Inc. is strictly prohibited. For further information contact the Publications Manager at PS Engineering, Inc., 9800 Martel Road, Lenoir City, TN 37772. Phone (865) 988-9800, email contact@ps-engineering.com.

Table of Contents

Section I – GENERAL INFORMATION	1-1
1.1 INTRODUCTION.....	1-1
1.2 SCOPE	1-1
1.3 EQUIPMENT DESCRIPTION	1-1
1.4 APPROVAL BASIS	1-2
1.5 SPECIFICATIONS.....	1-2
1.6 EQUIPMENT SUPPLIED.....	1-4
1.7 EQUIPMENT REQUIRED BUT NOT SUPPLIED	1-4
1.8 OPTIONAL ITEMS.....	1-4
1.9 LICENSE REQUIREMENTS	1-4
Section II - INSTALLATION	2-1
2.1 GENERAL INFORMATION	2-1
2.1.1 SCOPE.....	2-1
2.1.2 CERTIFICATION REQUIREMENTS.....	2-1
2.2 UNPACKING AND PRELIMINARY INSPECTION.....	2-1
2.3 EQUIPMENT INSTALLATION PROCEDURES	2-1
2.3.1 COOLING REQUIREMENTS.....	2-1
2.3.2 MOUNTING REQUIREMENTS.....	2-1
2.3.3 AUDIO PANEL MOUNTING RACK INSTALLATION	2-1
2.3.4 AUDIO PANEL TRAY AND CONNECTOR ASSEMBLY	2-2
2.4 CABLE HARNESS WIRING	2-2
2.4.1 NOISE	2-2
2.4.2 EXISTING GMA340 INSTALLATION	2-3
2.4.3 POWER	2-3
2.4.4 COMMUNICATIONS PUSH-TO-TALK	2-3
2.4.5 AUDIO PANEL INTERFACE	2-3
2.4.6 TEL (DUPLEX) FUNCTION FOR CELL PHONES	2-4
2.4.7 TRANSMIT INTERLOCK.....	2-4
2.4.8 "SWAP" MODE	2-5
2.4.9 BACKLIGHTING	2-5
2.4.10 UNSWITCHED INPUTS.....	2-5
2.4.11 PUBLIC ADDRESS MODE	2-6
2.4.12 PA MUTE (J2, PIN 12)	2-7
2.4.13 MISCELLANEOUS LOGIC OUTPUT (J2, PIN 18)	2-7
2.5 INTERCOM WIRING	2-7
2.5.1 ENTERTAINMENT INPUTS	2-7
2.5.2 ENTERTAINMENT MUTING.....	2-8
2.5.3 CONFIGURING MUSIC INPUT WITH FUNCTION KEYS	2-8
2.5.4 PLAYBACK BUTTON INSTALLATION	2-9
2.6 MARKER BEACON INSTALLATION	2-9
2.6.1 MARKER ANTENNA INSTALLATION	2-9
2.6.2 EXTERNAL MARKER LIGHTS	2-9
2.6.3 MIDDLE MARKER SENSE.....	2-9
2.7 ADJUSTMENTS.....	2-9
2.8 COMMUNICATIONS ANTENNA INSTALLATION NOTES	2-11
2.8.1 AUDIO ACTIVE OUTPUT.....	2-11
2.9 PMA8000B PIN ASSIGNMENTS	2-12
2.10 POST INSTALLATION CHECKOUT	2-13
2.11 UNIT INSTALLATION	2-13
2.12 OPERATIONAL CHECKOUT	2-13
2.12.1 REQUIRED TEST EQUIPMENT.....	2-13
2.12.2 AUDIO PANEL TEST	2-13

PS Engineering
PMA8000B Audio Selector Panel and Intercom System
Installation and Operator's Manual

2.12.3	MARKER CHECKOUT	2-14
2.12.4	TEL CHECKOUT	2-14
2.12.5	INTERNAL RECORDER CHECKOUT	2-14
2.12.6	FUNCTION BUTTON CHECKOUT	2-14
2.13	FINAL INSPECTION.....	2-14
	Section III OPERATION	3-1
3.1	SCOPE	3-1
3.2	COMMUNICATIONS TRANSMIT (XMT) SELECTION (2)	3-1
3.3	AUDIO SELECTOR (4).....	3-2
3.4	TELEPHONE (TEL) (9).....	3-2
3.5	SPEAKER AMPLIFIER (5).....	3-3
3.6	MARKER BEACON OPERATION (10).....	3-3
3.7	INTERCOM OPERATION	3-4
3.7.1	INTELLI VOX ® VOX-SQUELCH	3-4
3.7.2	INTERCOM VOLUME CONTROL (7).....	3-4
3.7.3	INTERCOM MODES (8)	3-5
3.8	MUSIC MUTING (6).....	3-5
3.9	TELEPHONE MODE (9).....	3-6
3.10	UTILITY JACK	3-7
3.10.1	CELLULAR PHONE.....	3-7
3.10.2	AUDIO ADVISORY INPUT.....	3-7
3.10.3	MUSIC INPUT	3-8
3.10.4	SMART FUNCTION KEYS (SFK).....	3-8
3.10.5	FUNCTION “A”	3-9
3.10.6	FUNCTION “B”	3-10
3.10.7	FUNCTION “C”	3-10
3.10.8	MUSIC 1 VOLUME.....	3-11
3.11	INTERNAL RECORDER	3-11
3.11.1	PLAYBACK.....	3-12
	Section IV – Warranty and Service	4-1
4.1	WARRANTY	4-1
4.2	FACTORY SERVICE	4-1
	Appendix A – External PTT Hook Up	A
	Appendix B – PMA 8000 Installation Drawings	B
	Appendix C – J1 Connector Interconnect.....	C
	Appendix D – J2 Connector Interconnect.....	D
	Appendix E – Instructions for FAA Form 337 and continuing airworthiness	E
9.1	INSTRUCTIONS FOR FAA FORM 337, AUDIO PANELS	E
9.2	INSTRUCTIONS FOR CONTINUING AIRWORTHINESS, AUDIO SYSTEM	E
	Appendix F – RTCA DO160D Environmental Qualification Form	F

Rev	Date	Change
1	10/31/05	1 st Release of new utility jack units
2	01/19/06	Changed functionality of Function A at S/N J01861
3	02/01/06	Updated for Unswitched 4 low, differential music notes, annunciation & playback.
4	06/08/06	Changed operation on IRS playback Section 3.12.1
5	05/30/06	Added back shell retainer
6	03/06/07	Updated cover
7	9/27/07	Clarified the unswitched audio distribution in Section 2.4.10
9	8/11/08	Clarified backlighting connection
10	11/20/08	Added info on PA jumper
11	12/15/08	Clarified music jack grounding
12	2/16/09	Updated IRS Operation
13	12/03/09	Added Multiple Music Muting Modes, TEL sidetone control, ISO music control

Section I – GENERAL INFORMATION

1.1 INTRODUCTION

The PMA8000B represents another evolutionary step in cockpit audio control and intercommunications utility. Using our patented *IntelliVox*® design, front panel utility jack, and pilot programmable configurations, this marks the next level of audio control. The unit is designed for outstanding ergonomics and visually defined mode annunciation and selection.

Before installing and/or using this product, please read this manual completely. This will ensure that you will take full advantage of all the advanced features in the PMA8000B.

1.2 SCOPE

This manual provides detailed installation and operation instructions for the PS Engineering PMA8000B-series of Audio Selector Panel/Intercom Systems. This includes the following units:

<u>Model</u>	<u>Description</u>	<u>Part Number</u>
PMA8000B	Stereo Audio Selector Panel with Marker Beacon, includes utility jack and Internal Recorder System	050-890-0202

1.3 EQUIPMENT DESCRIPTION

The PMA8000B is a state-of-the-art audio isolation amplifier and audio selector that contains an automatic voice activated (VOX) intercom system and integral marker beacon receiver. It can switch two transceivers (Com 1, Com 2) and six receivers (Nav 1, Nav 2, ADF, DME, MKR and AUX).

A full duplex TEL mode allows the PMA8000B to act as an audio interface between aircraft headphone and microphones and specific aircraft approved (FAA/FCC) cellular telephone equipment, through the front mounted jack.

Warning: Use of non-aviation approved cellular telephone equipment may be prohibited by regulation. PS Engineering is not responsible for unauthorized airborne use of cellular telephones. For airborne use, the PMA8000B must be interfaced with an approved system.

There are five unswitched inputs, available for traffic or EGPWS, autopilot disconnect, and/or radar altimeter warning, with the fifth unswitched input through a front-mounted utility jack, when configured to act as a fifth unswitched input.

Pushbuttons select the receiver audio source provided to the headphones. A SPR button allows the user to listen to the receiver(s) selected on the cabin speaker. Except for the unswitched inputs, all speaker audio is muted during transmit. Unswitched inputs 1,3, and 4 are always presented to the aircraft speaker. Unswitched input 2 will be presented to the speaker when the front panel SPR push button has been selected.

Pushbutton switches select one of the communication transceivers for the pilot and copilot position, and allows radio transmission. In "Split Mode" the PMA8000B has the ability to allow the pilot to transmit on Com 1 while the copilot can transmit on Com 2. A fail-safe mode connects the pilot headphone and microphone to COM 1 if power is removed for any reason, or if the power switch is placed in the Off (Fail-safe) position. Unswitched input #1 is also provided to the pilot headphone in fail-safe

A six-station voice activated (VOX) intercom is included in the PMA8000B. This system has PS Engineering's patented *IntelliVox*® circuitry that eliminates manual adjustments. The intercom system incorporates pilot isolate, all and crew modes, two independent stereo music inputs with "SoftMute™". Intercom volume control is through two concentric front panel knobs and a pushbutton intercom mode switch.

The small volume knob controls the intercom level for the pilot and copilot, while the large knob controls the passenger intercom volume. Intercom squelch is automatic.

A 3-light, 75 MHz Marker Beacon receiver is integrated in the PMA8000B. This provides the necessary Marker Beacon lights and audio indications necessary for that portion of an Instrument Landing System (ILS) approach. A pushbutton labeled MKR allows the pilot select high or low sensitivity as well as test and mute modes.

1.4 APPROVAL BASIS

FAA TSO Approval.

The PMA8000B-series Audio Selector Panels are FAA approved under TSO C50c (Audio Amplifiers) and TSO C35d (Marker Beacon Receivers), ETSO C50C/ and 2C53d.

All systems comply with relevant portions of EUROCAE RTCA MPS WG No. 7/70, DO-143 and (*Marker Beacon Receivers*), ED-14C/DO-160C (*Environmental Conditions and Test Procedures for Airborne Equipment*), ED12B/DO-178B, Level D (*Software Considerations for Airborne Equipment*) and ED-18/DO-214 (*Audio Systems Characteristics and Minimum Operational Performance Standards for Aircraft Audio Systems*).

Operation is subject to the following conditions:

This device may not cause harmful interference.

This device must accept any interference received, including interference that may cause undesired operation.

1.5 SPECIFICATIONS

TSO COMPLIANCE	
<i>Marker Beacon:</i>	FAA TSO C35d, Class A ETSO 2C35d
<i>Audio Selector/Intercom:</i>	FAA TSO C50c, Class 1a ETSO C50c
APPLICABLE DOCUMENTS:	RTCA/DO-214 RTCA/DO-143 RTCA/DO-160D RTCA/DO-178B DO-254
ENVIRONMENTAL Qualifications:	A1D1CABSMXXXXXXZBABATBXXE2XXX
<i>Operating Temperature Range:</i>	-15° C to 55°C
<i>Altitude:</i>	Up to 50,000 feet in a non-pressurized area
DIMENSIONS:	Height: 1.3 in. (3.3 cm) Width: 6.25 in. (16.9 cm) Depth behind panel 7.15 in. (18.16 cm)
WEIGHT <i>PMA8000B Unit</i> <i>Rack with connectors</i>	1.34 lb. (0.61 kg) 0.51 lb. (0.24 kg)
POWER REQUIREMENTS (Including Internal Lighting):	
<i>Voltage:</i>	11 to 33 VDC
<i>Maximum Current:</i>	2.5 Amp (Externally protected by a 5A pull-type breaker)

PS Engineering
PMA8000B Audio Selector Panel and Intercom System
Installation and Operator's Manual

Audio Selector Specifications	
<i>Audio selector panel input impedance:</i>	510 Ω
<i>Input Isolation:</i>	-60 dB (min.)
<i>Speaker Muting:</i>	-60 dB (min.)
<i>Speaker Output</i> (into 4 Ω) with no clipping 14 VDC: 28 VDC:	3 Watts (min.) 10 Watts (min.)
<i>Receiver Inputs:</i>	9 (Com 1, Com 2, TEL, Nav 1, Nav 2, ADF, DME, MKR, AUX)
<i>Unswitched Inputs:</i>	5 (including front jack)
<i>Transmitter Selections:</i>	4 (Com 1, Com 2, TEL Com1/2)
<i>Speaker Impedance:</i>	4 Ω
<i>Headphone Impedance:</i>	150 – 1000 Ω
<i>Headphone Output:</i>	38 mW each headset, no clipping <1% THD typical
<i>Microphone Impedance:</i>	150 - 600 Ω
Intercom Specifications	
<i>Intercom Positions:</i>	6 places (with individual <i>IntelliVox</i> ® circuits)
<i>Music Inputs:</i>	2, (Independent, Stereo)
<i>Music Muting:</i>	>-30 dB "Soft Mute" when Com or intercom active.
<i>Distortion:</i>	<1% THD @ 38 mW into 150 Ω
<i>Mic Freq. Response, 3 dB:</i>	300 Hz - 6000 Hz
<i>Music Freq. Response, 3 dB:</i>	10 Hz – 26 kHz
MARKER BEACON RECEIVER:	
<i>Frequency:</i>	75 MHz Crystal Controlled
<i>Sensitivity:</i> Low: High:	Capable of: (preset at factory for field application) 1000 μ Volts (Hard) (360 to 570 μ V soft) 200 μ Volts (Hard) (130 to 200 μ V soft)
<i>Selectivity:</i>	-6 dB at \pm 10 kHz -40 dB at \pm 120 kHz
<i>External Lamp Output:</i>	7.5 (\pm 4 VDC unloaded, at maximum brightness) VDC positive when active, max. current 125 mA
<i>MM Sense:</i>	Active high (4.5 \pm 1.0VDC)

1.6 EQUIPMENT SUPPLIED

1 ea. of the following units:

Model	Description	Part Number
PMA8000B	PMA8000B Audio Panel with Marker Beacon and Stereo intercom.	050-890-0202

PMA8000B Installation Kit: 250-890-0000

Description	Quantity	Part Number
PMA8000B installation rack assembly	1	430-890-0040
PMA8000B Rack back plate	1	430-890-0050
44-pin connector kit	2	120-891-2045-
Backshell, connector	2	625-025-2465
Backshell Retainer	2	431-881-0100
4 40 X 7/16 screw w/nylon patch	4	475-440-0007
4 40 X 3/8 screw w/lock washer	4	475-440-1038
4-40 Lock Nut	1	475-013-0001
Solder Lug	1	475-009-0001
Cable Clamp	1	625-001-0002
#6-32 x 1/2" Flat head Philips screw	6	475-632-0012
#6-32 Clip Nut	6	475-630-0002

1.7 EQUIPMENT REQUIRED BUT NOT SUPPLIED

- a. Circuit Breaker: 1 ea; 5 amp PULL TYPE REQUIRED for PMA8000B
- b. Speaker, 4 Ω
- c. Headphone Jacks (Stereo, as Required)
- d. Microphone Jacks (as Required)
- e. Headphones, 150 Ω (Stereo), up to 6 as required
- f. Microphones, up to 6 as required
- g. Marker Antenna (75 MHz, VSWR <1:1.5, and appropriate for the airspeed)
- h. Interconnect Wiring

1.8 OPTIONAL ITEMS

- a. Cell Phone Patch Cord, 2.5mm to 2.5mm, PS Part Number 425-006-7026
- b. Music Patch Cord, 3.5mm to 5.5mm, PS Part Number 425-006-2535

1.9 LICENSE REQUIREMENTS

None

Section II - INSTALLATION

2.1 GENERAL INFORMATION

2.1.1 SCOPE

This section provides detailed installation and interconnection instructions for the PS Engineering PMA8000B Audio Selector Panel/Intercom/ with internal Marker Beacon.

Please read this manual carefully before beginning any installation to prevent damage and post-installation problems. Installation of this equipment requires special tools, test equipment (refer to section 2.12.1) and knowledge as required by 14 CFR 65.81 (b).

2.1.2 Certification Requirements

NOTE

The PMA8000B requires specialized knowledge and tools for an effective installation. An appropriately rated Certified Aircraft Repair Station **must** install this equipment in accordance with applicable regulations. PS Engineering, Incorporated warranty is not valid unless the equipment is installed by an authorized PS Engineering, Incorporated dealer.

Failure to follow any of the installation instructions, or installation by a non-certified individual or agency will void the warranty, and may result in an **unairworthy** installation.

2.2 Unpacking and Preliminary Inspection

Use care when unpacking the equipment. Inspect the units and parts supplied for visible signs of shipping damage. Examine the unit for loose or broken buttons, bent knobs, etc. Verify the correct quantity of components supplied with the list in Section 1.6 (B). If any claim is to be made, save the shipping material and contact the freight carrier. Do NOT return units damaged in shipping to PS Engineering. If the unit or accessories show any sign of external shipping damage, contact PS Engineering to arrange for a replacement. Under no circumstances attempt to install a damaged unit in an aircraft. Equipment returned to PS Engineering for any other reason should be shipped in the original PS Engineering packaging, or other UPS approved packaging.

2.3 Equipment Installation Procedures

2.3.1 Cooling Requirements

Forced air-cooling of the PMA8000B is not required. However, the units should be kept away from heat producing sources (i.e. defrost or heater ducts, dropping resistors, heat producing avionics) without adequate cooling air provided.

2.3.2 Mounting Requirements

The PMA8000B must be rigidly mounted to the instrument panel of the aircraft structure, within view and reach of the pilot position(s). Installation must comply with FAA Advisory Circular AC 43.13-2A. The unit may be mounted in any area where adequate clearance for the unit and associated wiring bundle exist.

To prevent noise, avoid installing the unit close to high current devices or systems with high-voltage pulse type outputs, such as DME or transponders. Avoid running the interconnecting bundles near any high current wires.

2.3.3 Audio Panel Mounting Rack Installation

Remove the unit from the mounting tray by unscrewing the 3/32" hex-head screw that is in the center of the unit. Use caution to avoid hitting the photo-detector lens. Carefully slide the unit free of the tray. Set the unit aside in a safe location until needed. Install the tray using six clip nuts (475-630-0002), and six

FHP 6-32 x 1/2" screws (475-632-0012). The audio selector panel must be supported at front and rear of the mounting tray.

2.3.4 Audio Panel Tray and Connector Assembly

The rack connectors mate with two 44-pin connectors in the PMA8000B. The connectors are a sub-miniature crimp-type, and require the use a hand crimp tool, from table below (or equiv.). The connectors are mounted to the tray back plate with #4-40 screws (475-440-1038), from the inside of the tray and the mounting block, 431-891-0100. Ensure that proper strain relief and chafing precautions are made during wiring and installation, using the cable clamp (625-001-0002).

Manufacturer	Crimping Tool	Positioner	Extraction tool
AMP	601966-1	601966-6	91067-1
Daniels	AFM8	K42	M24308-1
ITT-Cannon	995-0001-584	995-0001-739	91067-1

Table 2-1 Connector Pin crimping tools

2.4 Cable Harness Wiring

Referring to the appropriate Appendix, assemble a wiring harness as required for the installation. All wires must be MIL-SPEC in accordance with current regulations. Two- and three-conductor shielded wire must be used where indicated, and be MIL-C-27500 or equivalent specification. Proper stripping, shielding and soldering technique must be used at all times. It is imperative that correct wire be used.

Refer to FAA Advisory Circular 43.13-2B for more information. Failure to use correct techniques may result in improper operation, electrical noise or unit failure. Damage caused by improper installation will void the PS Engineering warranty.

2.4.1 Noise

Due to the variety and the high power of radio equipment often found in today's general aviation aircraft, there is a potential for both radiated and conducted noise interference.

The PMA8000B power supply is specifically designed to reduce conducted electrical noise on the aircraft power bus by at least 50dB. Although this is a large amount of attenuation, it may not eliminate all noise, particularly if the amplitude of noise is very high. There must be at least 13.8 VDC present at the connector, J2 pins 8 & 9, of the PMA8000B for the power supply to work in its designed regulation. Otherwise, it cannot adequately attenuate power line noise. Shielding can reduce or prevent radiated noise (i.e., beacon, electric gyros, switching power supplies, etc.) However, installation combinations can occur where interference is possible. The PMA8000B was designed in a RFI hardened chassis and has internal Electro-magnetic Interference (EMI) filters on all inputs and outputs.

Ground loop noise occurs when there are two or more ground paths for the same signal (i.e., airframe and ground return wire). Large cyclic loads such as strobes, inverters, etc., can inject noise signals onto the airframe that are detected by the audio system. Follow the wiring diagram very carefully to help ensure a minimum of ground loop potential. Use only Mil Spec shielded wires (MIL-C-275000, or better). Under no circumstances combine a microphone and headphone wiring into the same shielded bundle. Always use a 2- or 3-conductor, shield wire as shown on the installation-wiring diagram.

The shields can be daisy-chained together, and then connected to a ground lug mounted on the corner of the back plate.

Radiated signals can be a factor when low level microphone signals are "bundled" with current carrying power wires. Keep these cables physically separated. It is very important that you use insulated washers to isolate the ground return path from the airframe to **all** headphone and microphone jacks.

2.4.1.1 Music Inputs and Noise

PMA8000B units above Serial Number J01861 utilize a differential input to help prevent noise from entering the music system. This feature is usually transparent to the installer, however, it is important that the appropriate music signal and ground connections are made directly to the dedicated music signal and ground inputs on the PMA8000B. The power for IFE and audio panel should be a common bus.

If a music jack instead of a music source is installed for Music 1 or 2, we recommend grounding the jack to airframe ground.

NOTE

Adding a high-performance audio control system, particularly in conjunction with high-performance active noise canceling headsets, cannot improve on older avionics that were designed for cabin-speaker use. PS Engineering makes no claim that the audio panel will provide a noise-free audio quality under all installation conditions, particularly with older avionics.

2.4.2 Existing GMA340 Installation

If the installation replaces a GMA340, no changes are necessary as long as the existing installation meets the requirements. All existing functions of the GMA340 as well as all of the new capabilities afforded by the PMA8000B will become instantly available. Be advised, the PMA8000B does not support 3 VHF Coms, however. The PMA8000B handles two COM transceivers and a full-duplex cellular/satellite telephone.

Added capabilities include, IntelliVox®, DuTel™ duplex telephone, improved music fidelity and Soft Mute™ and Karaoke™ muting modes, improved and more flexible music distribution control, internal recorder function, and additional unswitched audio inputs.

2.4.3 Power

The PMA8000B is compatible with both 14 and 28 Volt DC systems. A five (5) Amp circuit breaker is required for all installations. Power and ground wires should be #22 connected to J2 Pins 8 and 9. Connect airframe ground to J2 Pin 10 and 11 only. No dropping resistors are required.

2.4.4 Communications Push-to-Talk

An important part of the installation is the PTT (Push-To-Talk) switches that allow the use of your aircraft communications radio for transmissions. There are three typical configurations that can be used. Select the case that best fits the installation. Only the person who presses their PTT switch will be heard over the radio. If the pilot and copilot both use the PTT, the only pilot position has access to the radio. The pilot position will have PTT control regardless of the mic selector switch or copilot PTT when the PMA8000B is in the OFF/EMG mode.

CASE I: PTT is built into both pilot and copilot yokes.

CASE II: PTT is in pilot yoke only. This configuration requires a modified external PTT switch plugged into the copilot's microphone jack. (See Appendix A). When the copilot's PTT is pressed, the intercom switches the microphone audio from pilot to copilot mic.

CASE III: No built in PTT. This requires two built in PTTs to be installed, or modified external PTT switches to be used. Modify external PTT as required. See Appendix A.

2.4.5 Audio Panel interface

The PMA8000B is designed to interface with standard aircraft avionics, and presents a 510 Ω receiver impedance. For best results, a twisted-shielded cable is recommended from the avionics audio source to the audio panel, with the shield grounded at the audio panel end.

Some avionics do not provide a separate audio low, and may introduce additional electrical noise into the system. For best results, connect the audio low from the audio panel to the radio ground, using one conductor of the twisted-shielded cable.

2.4.5.1 Speaker Load

The PMA8000B contains one speaker amplifier. Some units with internal speaker amplifiers, such as the King Radio KX170-series, require a resistive load to prevent damage if their speaker amplifier is not used. Connect the speaker output from the unit to the COM 2 Speaker load input on the PMA8000B (J1 27 WRT 28). The speaker load is 16 Ω , 3W.

2.4.6 TEL (Duplex) Function for Cell Phones

This mode is designed to operate with telecommunications systems, such as the AirCell Guardian 1000. Audio streams selected by the intercom mode are provided to the Tel output, and audio from Tel is presented to the headset. This allows a telephone-like audio interface.

The TEL mode in the PMA8000B is also compatible with many cellular telephones with hands-free headset interfaces. The front panel 3/32" utility jack can be used as the interface to the Cell Phone, or a 3/32" jack can be installed somewhere on the aircraft panel. The wired interface jack is connected with the PMA8000B as shown: A patch cord (3/32" to 3/32") is available from PS Engineering under P/N 425-006-7026.

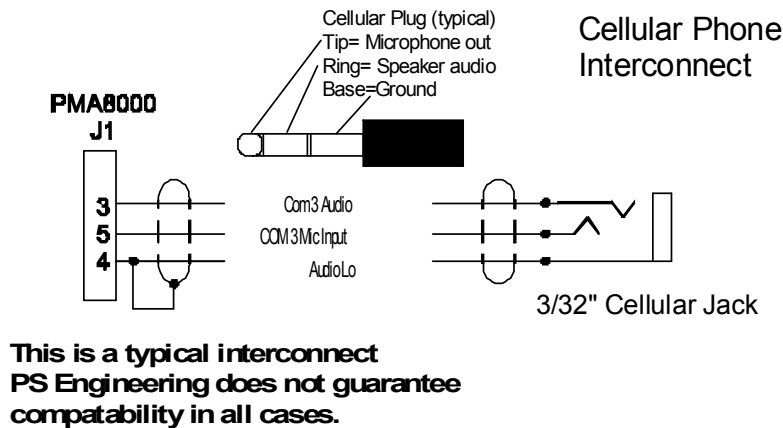

Figure 2-1 Cellular telephone interface for rear connector, if an additional jack is desired

2.4.6.1 Cell phone Sidetone

As shipped from PS Engineering, the PMA8000B does NOT provide cellular telephone sidetone (the user's voice fed back to the headset). Some cell phones do not provide sidetone. In PMA8000B MP3 Avidyne audio panels above serial number W04748, Telephone sidetone can be enabled by pressing the TEL and ADF buttons for more than one second. For units with serial number W04747 and below, an internal modification can be made that will allow the PMA8000B to provide sidetone. Contact PS Engineering for more information.

NOTE

Unauthorized use of unapproved cellular telephone devices in aircraft is subject to FCC enforcement action, which may include a \$10,000 fine per incident. PS Engineering, Inc. does not endorse using unapproved cellular telephone equipment in flight, and takes no responsibility for the user's action. PS Engineering does not guarantee compatibility with personal cellular telephones. For a list of phones that have been tested, visit www.ps-engineering.com.

2.4.7 Transmit Interlock

Some communications transceivers use a transmit-interlock system. To fully utilize the Split Mode feature, this function must be disabled. Consult that manufacturer's installation manual.

2.4.8 "Swap" Mode

When a momentary, normally open, push-button switch is connected between pin 20 on the J2 connector and aircraft ground, the user can switch between Com 1 and 2 by depressing this switch without having to turn the mic selector switch. This yoke-mounted switch eliminates the need to remove your hands from the yoke to change transceivers. The transfer of TX indication from Com 1 to Com 2 shows that the swap has been initiated; there is no dedicated swap indicator.

2.4.9 Backlighting

The PMA8000B has an automatic dimming of the pushbutton annunciation LEDs and marker lamps controlled by a photocell. Control of the unit backlighting is through the aircraft avionics dimmer. For 14 V aircraft, connect J2 Pins 6 and 7 to the aircraft dimmer bus, and pin 5 to ground. For 28-volt systems, connect pin 7 to the aircraft dimmer, and pins 5 and 6 to ground.

If an external dimmer control is **not** used, a constant back light illumination can be established for night-time viewing. Pin 6 or 7 (depending on system voltage) must be tied to power (J2, pin 8 or 9) for the back lighting system to work. The photocell mounted in the unit face will automatically adjust the intensity of the push-button annunciator LEDs.

2.4.10 Unswitched inputs

J1, pins 31, 29 and J2 pin 15 are unswitched, unmuted (by transmitter keying), inputs # 1, 3 and 4, respectively. These inputs are presented to the pilot and copilot regardless of the audio configuration, and will always mute the entertainment inputs. These 510Ω inputs can be used for altimeter DH audio, GPS waypoint audio, autopilot disconnect tones, or any other critical audio signal. Unswitched #1 is always presented to the speaker, plus to the crew headphones, and is available to the pilot in fail-safe (off) mode. Unswitched 3 and 4 inputs are always presented to the crew headphones and to the aircraft speaker.

Unswitched Input	Hear in Fail Safe	Hear in Crew Headset	SPR button Select	Gain
1	Yes	Yes	No	1:1(fixed)
2	No	Yes	Yes	1:1(fixed)
3	No	Yes	No	Adjustable
4	No	Yes	No	1:1(fixed)
5 (jack)	No	Yes	No	1:1(fixed)

Table 2-2 Unswitched input table

Unswitched #2, J1 pin 44 is unswitched is always connected to the Pilot's headphone. However, this unswitched audio is only presented to the aircraft speaker when the SPR push button has been selected. This input would be suitable for air-to-ground (Flitefone) telephone ringer. This input is not related to the cellular telephone interface.

The audio low for unswitched #4 (J2, pin 15) should be connected to a convenient audio low. However, this should NOT be connected to Music Low.

Unswitched #1 is presented to the pilot headphone in fail-safe (off) mode.

NOTE

Inputs 1, 2 and 4 are fixed (1:1), and any audio level adjustments must be made at the input source. Unswitched #3 has a variable adjustment control located on the bottom side of the unit. This control allows you to adjust the volume level of that unswitched input. Refer to Adjustments section.

The front panel jack can be configured to act as a fifth unswitched input. When configured through the front panel function switches (see operational section), the audio input to this jack will be presented to the pilot and copilot headsets, and not muted.

NOTE

The front-mounted utility jack is intended for portable equipment that is advisory in nature. It is NOT INTENDED for use as a primary warning channel. Audio of importance MUST ALWAYS be hard-wired into the unswitched inputs of the audio panel.

2.4.11 Public Address Mode

By pressing the Mute and SPR pushbuttons at the same time, the PMA8000B will be placed into public address (PA) mode. In this mode, the pilot will be talking over the cockpit speaker when he presses his PTT switch. Copilot will still continue on the selected COM radio.

To *enable* the PA Digital Output located at the rear connector, the internal configuration jumper, J4, MUST be placed across both pins in the header. This jumper is shipped as open from the factory.

When this Digital Output is enabled, J2 Pin 19 will go low when in PA mode, providing a logic level that can be used to incorporate a speaker-switching scheme. This 50 mA circuit (10 Ω Z) can control a switching means such as a relay that would transfer the speaker output amplifier from the cockpit speaker to drive another cabin speaker. If the PA mode is used with a microphone in proximity to an active cockpit speaker, feedback might result.

2.4.11.1 Public Address Jumper

1. Remove qty. 5 Phillip head screws from the PM8000B. **NOTE: THE SCREW IN THE REAR OF THE PANEL IS A DIFFERENT LENGTH THAN THE OTHER FOUR. YOU MUST PUT THE SHORTER LENGTH SCREW BACK IN THE SAME LOCATION OR DAMAGE WILL OCCUR. See Figure #1.**

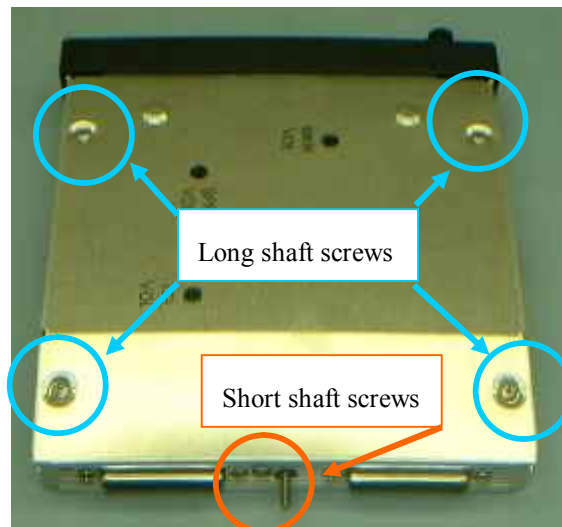

Figure 2-2 Screw Locations

2. Install the blue jumper located in the back corner near the sub-D connectors on *both* pins of J4. See Figure #2-3.



Figure 2-3 Jumper Location

4. Place the lid back on the unit, aligning holes.
5. Install and tighten qty. 4 long thread screws into the lid, and **one short screw on the rear**.

2.4.12 PA Mute (J2, Pin 12)

Pin 12 of J2 is a TTL logic output that is pulled low during PTT operation. This serves as an input to external public address system to prevent feedback during transmissions.

2.4.13 Miscellaneous Logic Output (J2, Pin 18)

Pin 18 of the J2 connector is pulled to ground whenever the AUX button is depressed. This serves as a control line for external devices, such as an entertainment system that the pilot wishes to control.

This pin can also be used to control passenger Karaoke Mode, by connecting to pin 13 of the J2, or as a PA cockpit/cabin speaker relay control.

NOTE

J2, Pin 18 should NOT be used if the AUX is going to be used to switch DME or auxiliary audio.

2.5 Intercom wiring

See Appendix C and D for intercom connection configurations. It is critical to the proper operation of this system to have this connector wiring made in accordance with these diagrams. Use 2- and 3-conductor, MIL-spec cable as shown. Connect the shields at the audio panel end only, and tie to the audio low inputs as shown.

NOTE

The intercom harness can be custom made by PS Engineering, Inc. Simply call the factory or www.ps-engineering.com to obtain a wire harness work sheet. The harness will be made to your specifications and fully functionally tested. Harness can be ordered with jack, or without the intercom jacks installed, for easier wire routing through the aircraft.

2.5.1 Entertainment Inputs

The PMA8000B has two INDEPENDENT music inputs, PLUS a front mounted jack that is connected to Entertainment 1. Entertainment input number 1 is J2 pins 23 (left channel) and 24 (right channel), with respect to pin 25, and Entertainment number 2 is connected to 26 (left channel), 27 (right channel), with respect to 28.

NOTE

Use the low level output of any additional entertainment device to connect to the audio panel. Maximum signal level is **3 VAC** p-p. **DO NOT** use a speaker-level output, this will cause internal damage in the audio panel.

2.5.2 Entertainment muting

The PMA8000B-system incorporates a "Soft Mute™" system. This will mute the entertainment devices during ICS or radio conversation. See [Section 3.8](#) for more information.

Any signal appearing in the hard wired unswitched audio inputs will always mute the entertainment sources, even though the passengers may not hear the audio tone itself.

Press the **Mute** switch to activate the four Karaoke modes (disabling crew SoftMute™). This allows the pilot to place the entertainment into the background while having the radios in the foreground. This eliminates the constant interruption of the music while still having the radios a priority.

CAUTION

Local oscillators and internal signals from entertainment equipment can cause undesired interference with other aircraft systems. Before takeoff, operate the entertainment devices to determine if there is any adverse effect within the aircraft systems. If any unusual operation is noted in flight, immediately switch off the entertainment devices.

All additional entertainment devices must be switched off for both takeoff and landing.

2.5.2.1 Entertainment 2 Mute (J2 Pin 13 & 14)

Connecting J2 pin 13 to pin 14 (or ground) through a SPST switch places the entertainment #2 music source into the Karaoke Mode. In this mode, incoming music and intercom conversation will not mute the music for the passengers' intercom net. This allows uninterrupted music during casual conversation and at times when radio communications are of lesser importance.

If desired, the AUX button can act as the passengers' mute control. Connect J2 pin 18 (AUX logic) to J2 pin 13 (Entertainment. 2 Mute inhibit).

2.5.3 Configuring Music Input with Function Keys

The two music inputs can be configured by the user from the front panel (see section 3.10). There are three configurations available, independent, ICS mode dependent, and single input.

If the inputs are independent, Input #1 (and the front jack) is provided to the pilot and copilot. Muting (SoftMute™) is controlled by the front panel "mute" button.

If the inputs are intercom mode dependent, input 1 goes to the pilot, copilot and all passengers when the intercom is in the "ALL" mode. In "ISO" mode, the copilot and passengers will hear music input 1. Music 2 is ONLY active in CREW mode, and then provided only to the passengers. The passenger SoftMute™ control becomes active in CREW.

If the single-source mode is activated through the function keys, the front panel jack (and music 1) is connected to all intercom positions, regardless of the intercom mode. Crew muting is controlled by the front panel, passenger muting controlled through the switch. See section 3.11 for more details.

2.5.3.1 Annunciation and recorder playback

In units above serial number J01861, the pilot and copilot can hear the Function Key annunciations. If the customer wants to exclude IRS and function key annunciation playback from the copilot position, contact PS Engineering for more information.

2.5.4 Playback button Installation

Internal Recorder can be played back from the front panel. A remote momentary, normally open (NO) push button switch may be installed if desired to remotely activate the Recording System playback. This switch can be located anywhere in cockpit convenient to the pilot's reach. The switch should be connected to pin 22 of J2 of the PMA8000B, and ground.

2.6 Marker Beacon Installation

2.6.1 Marker Antenna Installation

A marker beacon antenna, appropriate to the type and speed of the aircraft, is required (not included). Refer to aircraft and antenna manufacturer's installation instructions, as well as AC43.13-2A (or later revision), Chapter 3, for information on proper antenna installation techniques. The marker beacon antenna must be mounted on the bottom of the aircraft.

2.6.2 External Marker Lights

For installations that require external marker beacon lights, there are three outputs that can drive 12-Volt lamps only. The external output lamps are driven high (typically +9 VDC \pm 1.5 VDC unloaded, at MAX brightness) when active. Maximum source current per lamp is 125 mA. Voltage varies with photocell dimming.

2.6.3 Middle Marker Sense

A Middle Marker Sense output signal is available from the 8000 to flight control systems. This function will not operate during the test mode. This output will go to +4.5 VDC (\pm 1.0 VDC) when a valid Middle Marker signal is received. This output is J1, pin 39.

2.7 Adjustments

The PMA8000B is factory adjusted to accommodate the typical requirements for most aircraft configurations. There are three adjustments in the top cover that allow the installer to tailor the specific functions.

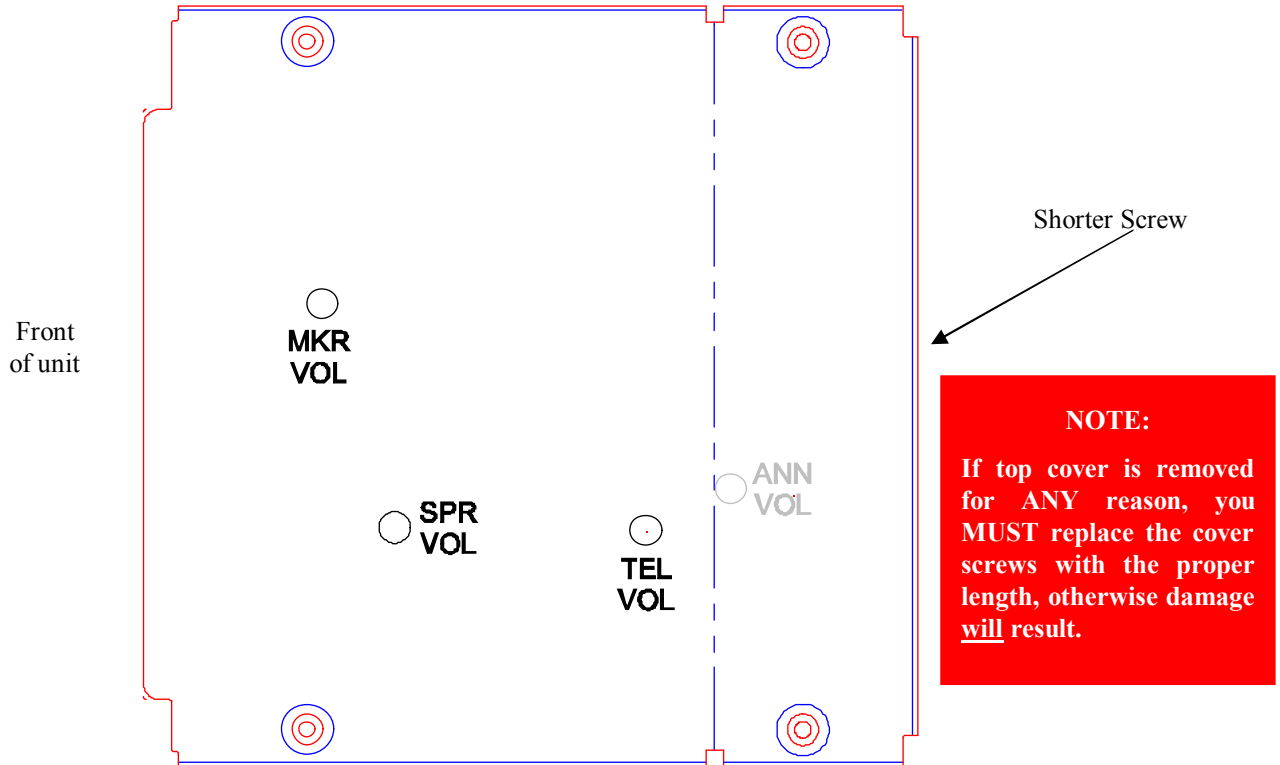

Figure 2-4- PMA8000B Adjustments, top cover

- Speaker Volume- Turn adjustment clockwise to increase cabin speaker output.
- Marker Beacon Volume, turn adjustment counterclockwise to increase marker beacon audio level.
- TEL volume, turn adjustment Clockwise to increase the incoming telephone audio.
- ANN VOL Function Mode Annunciation Volume – controls the level of the to access voice announcements contained in the unit. (Top cover must be removed).
- Unswitched Input 3 Volume, adjust from 50% to 200% of input value. (Bottom cover must be removed).



Figure 2-5 – Unswitched 3 Audio Level (bottom cover removed)

2.8 Communications Antenna Installation Notes

For best results while in Split Mode, it is recommended that the one VHF communications antenna is located on top of the aircraft while the other communications antenna is installed on the bottom. Any antenna relocation must be accomplished in accordance with AC 43.13-2A, aircraft manufacturers' recommendations and FAA-approved technical data.

WARNING

It is probable that radio interference will occur in the split mode when the frequencies of the two aircraft radios are adjacent, and/or the antennas are physically close together. **PS Engineering makes no expressed or implied warranties regarding the suitability of the PMA8000B in Split Mode.**

2.8.1 Audio Active Output

Pin 24 on the J1 connector (and PA Mute Pin 12 on J2) should be connected to Apollo CNX80 for audio message prioritization, refer to CNX80 installation manual for details.

2.9 PMA8000B Pin assignments

J1	Function	J2	Function
1	Mkr Ant	1	Pilot Phones Low
2	Mkr Ant Low	2	Copilot Phones Low
3	Telephone Audio in	3	Copilot Phones (L)
4	Telephone Low	4	Copilot Phones (R)
5	Telephone Mic Audio	5	Lights Low
6	Telephone Mic Key	6	14/28 V Lights
7	ADF Audio In	7	14/28 V Lights
8	ADF Audio Low	8	Aircraft Power
9	Com 1 Audio	9	Aircraft Power
10	Com 1 Audio Low	10	Aircraft Ground
11	Com 1 Mic	11	Aircraft Ground
12	Com 1 Mic Key	12	PA Mute
13	Com 2 Audio	13	Mute Inhibit
14	Com 2 Audio Low	14	Mute Inhibit Low
15	Com 2 Mic	15	Unswitched #4
16	No Connect	16	Pilot Phones (L)
17	Nav 1 Audio	17	No connect
18	Nav 1 Audio Low	18	Misc (AUX) logic output
19	Nav 2 Audio	19	PA Enable Output
20	Nav 2 Audio Low	20	Swap
21	DME Audio	21	Swap Low
22	DME Audio Low	22	IRS Playback
23	Auxiliary Audio Input	23	Music 1 (L)
24	CNX80 Inhibit	24	Music 1 (R)
25	No connect	25	Music 1 Low
26	No connect	26	Music 2 (L)
27	Com 2 Speaker Load	27	Music 2 (R)
28	Com 2 Speaker Load	28	Music 2 Low
29	Unswitched Audio 3	29	No Connect
30	Com 2 Mic Key	30	No Connect
31	Unswitched # 1	31	Pilot Phones (R)
32	Unswitched #1 Low	32	Copilot Mic Audio
33	Pilot Mic Audio	33	Copilot Mic PTT
34	Pilot Mic PTT	34	Copilot Mic Low
35	Pilot Mic Low	35	Pass 1 Mic Audio
36	Ext IM MKR	36	Pass 1 Mic Audio Low
37	Ext OM MKR	37	Pass 2 Mic Audio
38	Ext MM MKR	38	Pass 2 Mic Audio Low
39	MM Sense	39	Pass 3 Mic Audio
40	Pass HP (L)	40	Pass 3 Mic Audio Low
41	Pass HP (R)	41	Pass 4 Mic Audio
42	Pass HP Low	42	Pass 4 Mic Audio Low
43	Unswitched #2 Low	43	Speaker Low
44	Unswitched #2 Audio	44	Speaker Output

2.10 Post Installation Checkout

After wiring is complete, verify power is ONLY on pins 8 and 9 of the J2 and airframe ground on connector pins 10 and 11. Failure to do so will cause serious internal damage and void PS Engineering's warranty.

2.11 Unit Installation

To install the PMA8000B, gently slide the unit into the mounting rack until the hold-down screw is engaged. While applying gentle pressure to the face of the unit, tighten the 3/32" hex-head in the center of the unit until it is secure. DO NOT OVER TIGHTEN.

CAUTION

Apply steady pressure to the bezel while screwing the unit into the tray to ensure even seating of the unit and connectors.

WARNING

Do not over-tighten the lock down screw while installing the unit in tray. **Internal damage will result.**

2.12 Operational Checkout

2.12.1 Required Test Equipment

In order to return an aircraft to service after installation of the PMA8000B, the installer must have access to a Marker Beacon signal generator:

- a. IFR NAV401L, NAV402AP, IFR4000
- b. TIC T-30D, T-36C

Equivalent test equipment is acceptable as long as the testing requirements can be met.

2.12.2 Audio Panel Test

NOTE

The *IntelliVox*® is designed for ambient noise levels of 80 dB or above. Therefore some clipping may occur in a quiet cabin, such as without the engine running, in a hangar. This is normal.

1. Apply power to the aircraft and avionics.
2. Plug headsets into the pilot, copilot, and occupied passenger positions.
3. Verify fail-safe operation by receiving and transmitting on com 1 from the pilot position, with the audio panel power off. The Com audio will be present in one ear cup only.
4. Switch on the unit by pressing the volume (VOL) knob.
5. Check intercom operation.
6. Push the Com 1 Xmt select button (lower row).
7. Verify that both of the **Com 1** buttons light. Verify that transmit button LED (Light Emitting Diode) near the mic selector is not blinking. If the LED is blinking, stop testing and troubleshoot the microphone PTT installation.
8. Verify proper transmit and receive operation from the copilot position, noting that the copilot PTT switch allows proper transmission on the selected transceiver. Verify that the Com 1 Xmt button blinks when transmitting.
9. Verify that pushing the **COM 2** button causes the button to illuminate, and the Com 2 receiver to be heard. Verify operation on Com 1 from the pilot position.
10. Repeat for Com 2
11. Press and hold the Com 1 Xmt button. While holding the Com 1 button, press the Com 2 Xmt button. This places the unit in "split Mode;" Verify that the pilot can transmit and receive on Com 1, while the copilot transmits and receives on Com 2.
12. Verify proper operation of all receiver sources by selecting them using the appropriate button. The button illuminates to show which source is in use.

13. Push the SPR button. Verify that all selected audio is heard in the cockpit speaker. Verify that the audio mutes when the mic is keyed.
14. Verify that the appropriate LED in the lower button row blinks when either push to talk is keyed.
15. Verify proper Intercom system operation in the **ALL**, **ISO** and **CREW** modes (see Table 3-1).
16. Verify that the audio selector panel system does not adversely affect any other aircraft system by systematically switching the unit on and off, while monitoring the other avionics and electrical equipment on the aircraft.

2.12.3 Marker Checkout

1. Connect a ramp generator at the antenna end of the marker coax. With the unit under test in HI sensitivity, verify that a 160 μ V, modulated 95% with 1300 Hz, signal will illuminate the amber (M) marker light, and that marker audio is present in the headphones when the Marker Audio (M) push-button has been depressed. Select SPR for speaker to verify marker audio availability on the cabin speaker. Verify that the white (I) and blue (O) lights will illuminate within ± 3 dB of the amber lamp, with 3000 HZ and 400 Hz applied, respectively.
2. Repeat with the unit in LOW sensitivity, with 430 μ Volts applied.
3. Connect the marker antenna and verify proper operation.

2.12.4 TEL Checkout

Press the TEL button. Verify that the pilot headset is connected to the cellular telephone system (if installed). Verify that by using the pilot side PTT, the pilot can transmit on the other selected radio (Com 1 or Com 2). The telephone function will allow any person heard by the pilot on the intercom, also heard on the telephone.

2.12.5 Internal Recorder Checkout

With headset plugged into pilot's side jacks, tune COM 1 to local frequency, such as FSS or ATC ground. Select Com 1 on mic selector switch, and record several incoming radio transmissions.

Press the Com receiver pushbutton that corresponds to the selected radio transmitter and Hold for approximately one second. This action will then automatically play back the last recorded message. Press and HOLD both buttons again to stop the play back, and then momentarily press again to play prior messages.

This audio should appear in the pilot and copilot headsets, and only be incoming transmissions from the transceiver selected in the mic select switch. Depress the audio panel or yoke mounted playback switch, and verify that messages play, in the order received. Repeat for COM 2. The playback will be stopped by audio on the selected com. The message can be replayed from the beginning, and audio received during the playback will not be stored.

2.12.6 Function Button Checkout

While listening to the pilot's headset, press and hold the "TEL" button. Press the AUX, MUTE and SPR buttons, verifying that the annunciations play back in pilot headset. See operation section for information. Incoming audio on selected com will stop the audio.

2.13 Final Inspection

Verify that the wiring is bundled away from all controls and no part of the installation interferes with aircraft control operation. Move all controls through their full range while examining the installation to see that no mechanical interference exists. Verify that the cables are secured to the aircraft structure in accordance with good practices, with adequate strain relief. Ensure that there are no kinks or sharp bends in the cables and coaxial cables. Verify that the cables are not exposed to any sharp edges or rough surfaces, and that all contact points are protected from abrasion.

Complete documentation that may be required, such as a logbook entry, weight and balance computation and FAA Form 337. Sample text for FAA Form 337, and instructions for continuing airworthiness can be found in Appendix F. Return completed warranty registration application to PS Engineering, or complete online at www.ps-engineering.com.

Section III OPERATION

3.1 SCOPE

This section provides detailed operating instructions for the PS Engineering PMA8000B, Audio Selector Panel/Marker Beacon Receiver/Intercom Systems. Please read it carefully before using the equipment so that you can take full advantage of its capabilities.

This section is divided into five sections covering the basic operating areas of the PMA8000B systems. They are Communications Transceiver Selection, Audio Selector, Intercom, Marker Beacon Receiver and special functions.

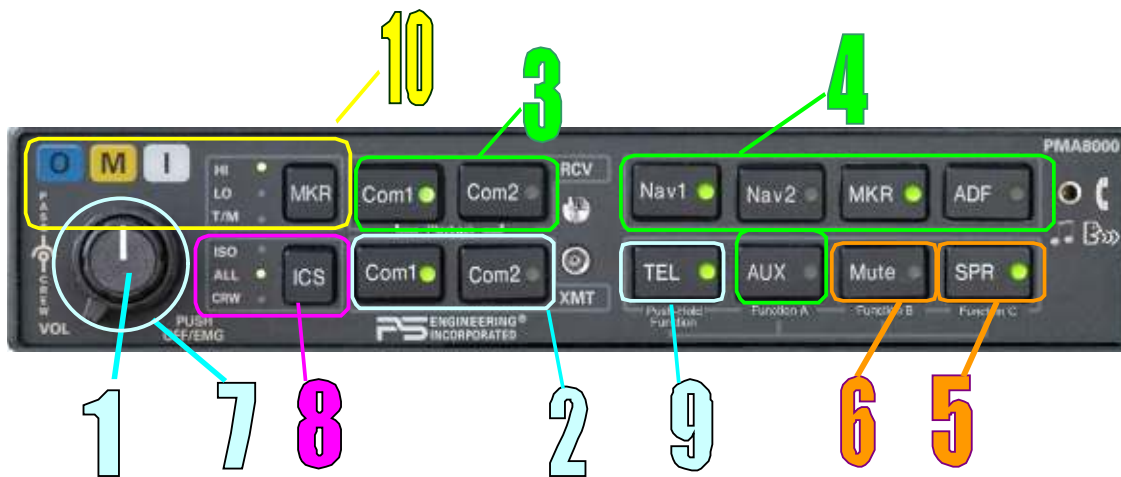

Figure 3-1 PMA8000B Operating Controls

Unit power is turned on and off by pushing the volume knob. In the OFF or "EMG" position, the pilot headset is connected directly to Com 1 as well as unswitched input #1. This allows communication capability regardless of unit condition. Any time power is removed or turned OFF, the audio selector will revert to fail-safe mode.

The power switch controls all audio selector panel functions, intercom and marker beacon receiver. All pushbutton selections and function modes will be remembered and return to the last state when turned on.

3.2 Communications Transmit (XMT) Selection (2)

There are two pushbuttons associated with the transmitter selection. The two lower buttons (# 2) control which transceiver is selected for transmit. The top row of pushbuttons (# 3) allows selection of the receiver audio. Push the lower button to select the desired COM transmitter.

The PMA8000B-Series has an automatic selector system. Audio from the selected transceiver is automatically heard in the headsets and speaker (if selected). You can check this function by switching from COM 1 transmitter to Com 2 transmitter by pressing the COM 2 transmitter selector pushbutton. See that the associated Com 2 receive pushbutton indicator light that is located immediately above the Com 2 transmitter pushbutton turns green. This guarantees that the pilot will *always* hear the audio from the transceiver selected for transmit.

The PMA8000B "remembers" the receiver selection, so that when switching transmitters from COM 1 to COM 2, if COM 2 audio was previously selected, COM 1 audio will continue to be heard. This eliminates the pilot having to switch Com 1 audio back on, after changing transmitters.

When switching from COM 1 to COM 2 while Com 2 was not previously selected, COM 1 audio will be switched off. In essence, switching the mic selector will not override prior selection of COM receiver audio.

In normal (not split) modes, the PMA8000B gives priority to the pilot's radio Push-To-Talk (PTT). If the copilot is transmitting, and the pilot presses his PTT, the pilot's microphone will be heard over the selected com transmitter.

In TEL mode, the pilot microphone and headphones are connected to the cell phone. The pilot PTT will switch the pilot mic to the selected com transceiver, and allow continued aircraft communications to continue. (See Section 3.4 —TEL—for more details)

The copilot will also be able to transmit on the other selected radio with his PTT as well.

3.2.1.1 Split Mode

The split mode can be activated at any time by pressing the **COM 1** and **COM 2 XMT** buttons at the same time. This places the pilot on COM 1 and the Copilot on COM 2.

Pilot on COM 2 and Copilot on COM 1 is not possible.

NOTE

Due to the nature of VHF communications signals, and the size constraints in general aviation aircraft, it is probable that there will be some bleed-over in the Split mode, particularly on adjacent frequencies. PS Engineering makes no warranty about the suitability of Split Mode in all aircraft conditions.

When the split mode is activated, the intercom between the pilot and copilot is inhibited, although the passengers can still talk among themselves. The crew intercom can be reactivated if desired by pressing the "Mute" button. The indicator LED in the Mute button will be green when the intercom is off (muted), and turn off to indicate that the intercom is not muted, and the crew can speak to each other.

3.2.1.2 Swap Mode (Switch from Com 1 to Com 2 remotely)

With a yoke mounted, normally open momentary switch, the pilot can change from the current Com transceiver to the other by depressing this switch. To cancel "Swap Mode," the pilot may either press the yoke mounted switch again, or select a different Com with the XMT buttons.

3.3 Audio Selector (4)

Communication audio from the other radio, not selected for transmit, can be heard by pressing the associated RCV button. You will always hear the audio from the selected transceiver.

Navigation receiver audio is selected through five momentary, push-button, backlit switches.

The users can identify which receivers are selected by noting which green switch LEDs are lit. Navigation aid audio push buttons are labeled **Nav 1**, **Nav 2**, **MKR** (Marker), **ADF** and **AUX** (auxiliary). DME audio (if present) will come through when the **AUX** button is selected. When one of these buttons is pressed, the mode is active, and the LED will illuminate. Press the switch again and it will be "off" and remove that receiver from the audio output.

In SPLIT mode, only the pilot will hear selected navigation audio.

3.4 Telephone (TEL) (9)

The TEL mode serves as a full duplex interface and distribution for telephone systems such as AirCell or portable cellular phones with earpiece jacks. Pressing the TEL button activates the telephone mode.

This connects the telephone to the users as follows:

In **ALL** intercom mode, all crew and passengers will be heard on the phone when they speak. Com and other selected radio audio is also heard in the headsets. If the pilot or copilot pushes the radio PTT, their mic will be transferred to the selected Com radio. The telephone party will not hear ATC communications, and vice versa.

In **CREW** mode, only the pilot and copilot are connected to the telephone. Passengers will not hear the telephone. The pilot and copilot will also have transmit capability on the other selected transceiver.

In **ISO** intercom mode, when the PMA8000B is in the **TEL** mode, the pilot position is in the "Phone Booth." Only the pilot will hear the telephone, and only he will be heard. He will also have access to Com 1 or 2, and will transmit on that radio using the PTT. All selected audio is provided to the pilot.

NOTE

Because the cell-phone uses an intercom circuit, all stations on that circuit will lose intercom capability when the cell phone is in use.

3.4.1 Cell phone Sidetone

As shipped from PS Engineering, the PMA8000B does NOT provide cellular telephone sidetone (the user's voice fed back to the headset). Some cell phones do not provide sidetone. In PMA8000B MP3 Avidyne audio panels above serial number W04748, Telephone sidetone can be enabled by pressing the TEL and ADF buttons for more than one second. For units with serial number W04747 and below, an internal modification can be made that will allow the PMA8000B to provide sidetone. Contact PS Engineering for more information.

3.5 Speaker Amplifier (5)

The **SPR** in the lower right section stands for speaker. This switch will place all selected audio on the cockpit speaker when this switch is selected. Except for the unswitched audio, the speaker amplifier is not active in the "Split Mode".

Unswitched audio, (the inputs dedicated to autopilot disconnect, altimeter warning, etc.) will come through the speaker regardless of the speaker button position.

Depending on installation, important audio annunciations such as radar altimeter or autopilot disconnect will come over the speaker even if it is not selected, while other unswitched, but muted inputs, such as GPS alerts, will only be present if the SPR button is selected. Consult your professional avionics installer for these important configuration details.

3.5.1.1 Public Address Function

To access PA function, press the **Mute** and **SPR** buttons simultaneously. The pilot microphone will be heard on the speaker when the pilot PTT is used. The copilot can continue to use the selected com radio while the pilot will now be heard over the speaker. During Public Address, the **Mute** and **SPR** buttons will flash. To exit PA mode, push **Mute** and **SPR** again.



3.6 Marker Beacon Operation (10)

The Marker Beacon Receiver uses visual and audio indicators to alert you when the aircraft passes over a 75 MHz transmitter.

The Blue lamp, labeled "O", is the Outer Marker lamp and has an associated 400-Hertz 'dash' tone. The lamp and tone will be keyed at a rate of two tones/flashes per second when the aircraft is in the range of the Outer Marker Beacon.

The Amber lamp, labeled "M", is the Middle Marker lamp and is coupled with a 1300 Hertz tone. It is keyed alternately with short 'dot' and long 'dash' bursts at 95 combinations per minute.

The White lamp, labeled "I", is the Inner marker and has a 3000 Hertz 'dot' tone. The lamp and tone will be keyed at a rate of six times per second.

The audio from the Marker Beacon Receiver can be heard by selecting the "**MKR**" push-button switch. To adjust the volume level, there is a service adjustment located on the top of the unit.

A pushbutton is used to set the receiver sensitivity and to test the indicator lamps mute the marker audio.

Use "**HI**" sensitivity initially. This allows you to hear the outer marker beacon about a mile out. Then touch the smaller MKR button to switch into Low Sensitivity mode. "**LO**" sensitivity gives you a more accurate location of the Outer Marker. Holding the MKR button for one second activates marker test lamp, labeled "T/M" and illuminates all three lamps simultaneously to assure the lamps (internal and ex-

ternal) are in working order. TST does not activate MM autopilot sense output. Releasing the button returns to the last sensitivity.

Pressing the marker mode select (“T/M”) for one second will also cause the marker audio to mute for that beacon. The next beacon received will re-activate the audio.

3.7 Intercom Operation

3.7.1 IntelliVox® VOX-Squelch

No adjustment of the *IntelliVox*® squelch control is necessary. There is no field adjustment. Through three individual signal processors, the ambient noise appearing in all six microphones is constantly being sampled. Non-voice signals are blocked. When someone speaks, only their microphone circuit opens, placing their voice on the intercom.

The system is designed to block continuous tones; therefore people humming or whistling in monotone may be blocked after a few moments.

For consistent performance, any headset microphone **must** be placed within ¼-inch of your lips, preferably against them. (ref. *RTCA/DO-214, 1.3.1.1 (a)*).

NOTE

It is also a good idea to keep the microphone out of a direct wind path. Moving your head through a vent air stream may cause the *IntelliVox*® to open momentarily. This is normal.

The *IntelliVox*® is designed to work with normal aircraft cabin noise levels (70 dB and above). It loves airplane noise! Therefore, it may not recognize speech and clip syllables in a quiet cabin, such as in the hangar, or without the engine running. This is normal.

For optimum microphone performance, PS Engineering recommends installation of a Microphone Muff Kit from Oregon Aero (1-800-888-6910). This will not only optimize VOX performance, but will improve the overall clarity of *all* your communications.

Table 3-1 Mic Muff™ Part Numbers

Manufacturer	Model	Mic Muff™ Part Number
Bose	Dynamic	90010
	Electret	90015
	M87 Dynamic	90020
David Clark	H10-30	90010
	H10-20, H10-40	90015
	H10-13.4	90015
Lightspeed	All	90015
Peltor	7003	90010
	7004	90015
Pilot	11-20 & 11-90	90015
Sennheiser		90015
Telex	Airman 750, Echelon	90015
	AIR3000	90010

3.7.2 Intercom Volume Control (7)

The inner volume control knob adjusts the loudness of the intercom for the pilot and copilot. It has no effect on selected radio levels, music input levels or passengers' volume level.

The outer volume control knob controls intercom volume or the passengers. It has no effect on radio or music levels.

Adjust the radios and intercom volume for a comfortable listening level. Most general aviation headsets today have built-in volume controls; therefore, volume also can be further adjusted at the individual headset.

3.7.2.1 Mono headsets in Stereo Installation

The pilot and copilot positions work with stereo or mono headsets. All passenger headsets are connected in parallel. Therefore, if a monaural headset is plugged in to a PMA8000B Stereo installation, one channel will be shorted. Although no damage to the unit will occur, all passengers will lose one channel, unless they switch to the "MONO" mode on the headset. PS Engineering modifies headsets to add stereo capability, using high-fidelity speakers. Contact factory for details.

3.7.3 Intercom Modes (8)

The "ICS" pushbutton switch on the left side of the panel provides the selection of the three intercom modes. The description of the intercom mode function is valid only when the unit is not in the "Split" mode. Then, the pilot and copilot intercom is controlled with the **Mute** button.

This button cycles through the intercom modes, from top to bottom, then bottom to top as: ISO, ALL Crew and Crew, ALL, ISO. An LED shows which mode is currently active.

ISO: The pilot is isolated from the intercom and is connected only to the aircraft radio system. He will hear the aircraft radio reception (and sidetone during radio transmissions). Copilot will hear passengers' intercom and entertainment, while passengers will hear copilot intercom and entertainment. Neither will hear aircraft radio receptions or pilot transmissions. The pilot can hear music if desired. See §3.8.1

ALL: All parties will hear the aircraft radio and intercom. Crew and passengers will hear selected entertainment. During any radio or intercom communications, the music volume automatically decreases. The music volume increases gradually back to the original level after communications have been completed.

CREW: Pilot and copilot are connected on one intercom channel and have exclusive access to the aircraft radios. They may also listen to Entertainment 1. Passengers can continue to communicate with themselves without interrupting the Crew and may listen to entertainment as configured.

3.8 Music Muting (6)

[Serial Number W04587 and below] There are two SoftMute™ muting circuits. The SoftMute™ circuit will cut the music almost completely out whenever there is conversation on the radio or intercom. When that conversation stops, the music returns to the previous level comfortably, over a second or so.

The pilot and copilot have one muting circuit, which is controlled by the front panel button labeled "Mute." When this button is pressed, the PMA8000B will be put into a Karaoke mode. The music will not be muted, ever.

The passenger's intercom also has a SoftMute™ circuit. It behaves the same way as the crew, such that if the passengers will hear the radio, or talk on the intercom, the music will mute. If the audio panel is in CREW mode, then the radio reception will not affect the passenger music.

There is a Karaoke Mode that is activated either by an external switch installed either in the panel or near where the passengers can reach it, or connected to the AUX button on the PMA8000B.

[Serial Number W04748 and above] The front panel "Mute" button has **four** modes, and controls the Mute function for Music 1.

The SoftMute™ circuit will cut the music out whenever there is conversation on the radio, the intercom, or both, depending on the "Mute" mode selected. When that conversation stops, the music returns to the previous level comfortably, over a second or so.

The mute mode functions are controlled through sequential pushes of the Mute button, and include announcements of the mode selected.

Mode 1 - music **will** mute with *either* intercom *or* radio - MUTE button is lit. Voice announcement is "mute on."

Mode 2 - "Karaoke" mode - music will not mute except during transmissions.- MUTE LED is OFF. Annunciation is "mute off."

Mode 3 - *Radio* will mute music, but intercom will **not** mute music - MUTE LED is OFF. Annunciation is "radio mute."

Mode 4 - Radio will **not** mute music, intercom *will* mute music - MUTE LED is OFF. Annunciation is "intercom mute."

🎵 Music	Intercom	Radio	Annunciation	LED
Mode 1	Muted	Muted	"Mute on"	on
Mode 2	🎵	🎵	"Mute off"	off
Mode 3	🎵	Muted	"Radio mute"	off
Mode 4	Muted	🎵	"Intercom mute"	off

The passenger's intercom also has a SoftMute™ circuit. If the passengers hear the radio, or talk on the intercom, the music will mute. If the audio panel is in CREW mode, then the radio reception will not affect the passenger music.

Passengers also have a Karaoke Mode. If the passengers are listening to the music 1 input or front panel input, their Karaoke Mode is controlled by the front panel "Mute" button. If the passengers are listening to the music 2 input, their Karaoke Mode is activated by an external switch installed either in the panel, or connected to the AUX button logic output pin on the PMA8000B MP3.

3.8.1 Music in Pilot ISO mode

If desired, the pilot can elect to hear Music #1, I the ISO mode. While the intercom is in ISO mode, push the Function (TEL) and ICS buttons at the same time. This mode will be indicated by the ICS ISO LED blinking slowly (once in every 5 seconds). The pilot will now hear Music #1, and it will mute in accordance with the Mute mode as described in §3.8.

3.9 Telephone Mode (9)

The TEL mode serves as a full duplex interface for telephone systems such as AirCell or portable cellular phones with earpiece jacks. When interfaced with an approved airborne telecommunications system, the PMA8000B can serve as a audio control and distribution center. When TEL is active, the button will blink about twice as fast as the normal transmit rate.

In **ALL** intercom mode, all crew and passengers will be heard on the phone when they speak. All will hear selected audio. Com audio is automatically heard in the headsets.

In **CREW** mode, the pilot and copilot are connected to the telephone. The pilot and copilot will have transmit capability on the other selected transceiver Com 1 or 2, simply by using their respective PTT switch.

In **ISO** intercom mode, when the PMA8000B is in the **TEL** mode, the pilot position is in the "Phone Booth." Only the pilot will hear the telephone, and only he will be heard. He will also have access to Com 1 or 2, and will transmit on that radio using the PTT. All selected audio is provided.

NOTE

Because the cell phone uses an intercom circuit, all stations on that circuit will lose intercom capability when the cell phone is in use. Intercom conversations will still be present if the cell phone provides sidetone, or if the audio panel is modified for telephone sidetone.

PS Engineering does not guarantee compatibility with personal cellular telephones.

Visit www.ps-engineering.com for a list of phones that have been tested.

3.9.1 Cellular telephone sidetone

As shipped from PS Engineering, the PMA8000B does NOT provide cellular telephone sidetone (the user's voice fed back to the headset). Some cell phones do not provide sidetone. In PMA8000B MP3 Avidyne audio panels above serial number W04748, Telephone sidetone can be enabled by pressing the TEL and ADF buttons for more than one second. For units with serial number W04747 and below, an internal modification can be made that will allow the PMA8000B to provide sidetone. Contact PS Engineering for more information.

3.10 Utility Jack

The 2.5-millimeter (3/32") jack on the front of the PMA8000B has three distinct functions:

- Cell phone input
- Advisory audio input
- Music input

The use of this jack is controlled by three Smart Function Keys (SFK) controlled from the front panel. See Section 3.11 — Smart Function Keys.

3.10.1 Cellular phone

When a cellular telephone is connected to this jack using a 2.5 mm to 2.5 mm adapter cord (PS Part Number 425-006-7026), the PMA8000B audio panel will connect the intercom to the cell phone when the "TEL button is pressed (9), and behave as described in section 3.7. The telephone ringer, if present, will be heard unless the input is muted by other radio or intercom.

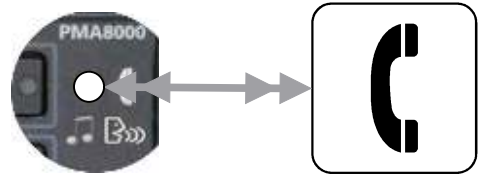

3.10.2 Audio Advisory Input

Serial J01861 and above: The front jack can be used as a priority advisory input for auxiliary systems such as a GPS terrain advisory or portable traffic watch system. To prevent radio or intercom from muting this input, press the "Mute" button.

3.10.2.1 Smart Jack Function

When the PMA8000B has a signal on music #1 input coming in from the rear connector, the front panel jack automatically becomes a Priority Advisory input, and is heard in the crew headphones.

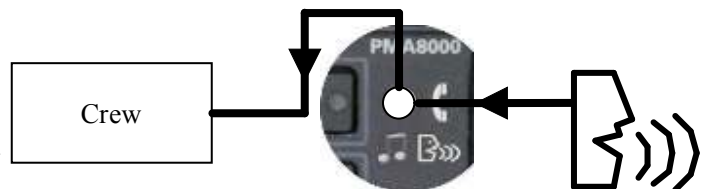

NOTE

The front jack is no substitute for the certified installation of alerts such as the GPS waypoint or autopilot tones. These still must be hard wired into the back by your installer.

[**Before Serial Number J01861** The front jack can be configured to be a priority advisory input for auxiliary systems such as a GPS terrain advisory or portable traffic watch system. When configured as priority, the audio is presented to the pilot and copilot only, and is NOT muted by radio or intercom activity. Connect the jack (J) to the output of the device with the advisory audio. The jack priority mode is activated by pressing the Function Control F (TEL) and Function A (AUX) buttons at the same time. To disable the jack as priority, select any other function. NOTE: This function not present in serial number J01861 and above]

3.10.3 Music Input

When used as a music input, the front panel jack is treated as Music #1. However, thanks to the function controls, it can be distributed to all users, regardless of the intercom mode. A patch cord is available with 2.5 mm to 3.5 mm (3/32 to 1/8") adapter cord (PS Part Number 425-006-2535).

3.10.4 Smart Function Keys (SFK)

With Virtual Tech Support, the configuration process is self-directed. Once you've set up your system, you don't need to change it again, unless you want to. The unit will always remember your settings.

SFK annunciations are heard by the pilot and copilot positions only. SFK annunciations will be heard by the copilot, even when the audio panel is in pilot isolate mode. These annunciations will be stopped by any audio received on the com radio selected for transmit (software level BPBC and above).

Function A AUX		Function B MUTE		Function C SPR	
Jack Mode		Music 1 Distribution		ICS Mode Dependence	
State 1	State 2	State 1	State 2	State 1	State 2
"Front jack priority, no muting"	"Front jack music, with muting"	"Music number 1 all headsets"	"Music number 1 standard distribution."	"Standard Music distribution "	"Alternate Music distribution "

Table 3-2 SFK Functions Serial Number J01860 and below

Function A AUX		Function B MUTE		Function C SPR	
Intercom mode		Music 1 Distribution		ICS Mode Dependence	
State 1	State 2	State 1	State 2	State 1	State 2
"Alternate intercom function"	"Standard Intercom Function"	"Music 1 all headsets"	"Music 1 distribution crew."	"Standard Music Distribution	"Alternate music distribution "

Table 3-3 - SFK Functions, PMA8000B Serial Number J01861 and above



Figure 3-2 Smart Function Keys

These functions are non-essential and non-required and as such are only an accessory capability. They don't affect the audio panel's primary function as a selector panel, aircraft intercom, or marker beacon receiver. You can't do anything with these buttons to prevent the PMA8000B from doing its main job.

Looking at the front panel you'll notice that the TEL, Aux, Mute and SPR buttons have "Function" assignments.

To use these function keys A, B, C – press and hold "F" and then press the desired key, "A" "B" or "C".

There are three special functions. Function Button "A" is related to the front panel utility jack (J) and tells the audio panel to treat the jack either as music, or as what we call an unswitched, priority audio source.

Function Buttons "B" and "C" control how music is distributed in your airplane.

There are two music sources available to the PMA8000B. Music 1 input can be either on the front jack, OR the Music 1 input at the rear connector (Pins 23 and 24 J2). Music 2 is wired into the rear connector, only (Pins 26 and 27, J2)

3.10.5 Function "A"

Serial Number J01861 and above: Function "A" controls the distribution of aircraft radio within the intercom, as well as passenger intercom muting. In the "*standard intercom function*" mode, aircraft radios are distributed to all, when the intercom is in the ALL mode. In CREW mode, only the pilot and copilot positions will hear aircraft radios.

When Function A is toggled into "*Alternate Intercom Function*," the passengers will NOT hear aircraft radios, even in the all mode. They will be able to converse with the crew. However, when the aircraft radio becomes active, the intercom audio from the passengers is muted, allowing the crew to focus on the radio. The passengers will still be able to talk to each other.

Serial Number J01860 and below: Function "A" controls the *priority of the front jack* (labeled J in the diagram). When you push Function A, you will hear either "*Front Jack Priority*" Or "*Front Jack Music*" depending on the previously selected mode.

When in Front Jack Priority mode, the jack is configured to present the audio input in the jack to the pilot and copilot headphones, and that it will NOT be muted like the music.

This function is selected, this audio input will not mute other entertainment sources, unlike other unswitched inputs.

If you set the jack up as priority, and then connect music, such as an XM or SIRIUS radio, this *will not be muted* by radio and intercom. The passengers will NOT hear this audio, either.

Pushing Function “A” again will toggle to the other mode. In this case, the Front Jack Music makes the front panel utility jack a music source, as a convenient place to plug in an iPod. You will hear, “*Front Jack, Music with muting.*” This music input will act just like a standard music input of the audio panel, allowing either SoftMute or karaoke modes.

If you plug a telephone into the jack, it will function as full duplex phone when the “TEL” button is pressed, regardless of the Function “A” selection. If Function A is set for priority, any ringer audio will come into the pilot and copilot headphones at the same level as a radio input. If the jack is set for music, any ringer audio will be treated as music, and mute according to the rules.

We’ve built some intelligence into the PMA8000B, too. If you have Music 1 connected to the rear pins, and there is music playing, the PMA8000B “knows” that what you put into the front jack must be a priority. So the unit will automatically switch the jack to the priority mode.

3.10.6 Function “B”

Function Button “B” allows you either send the music 1 input to all intercom stations, all of the time, or have the normal rules apply to our music inputs.

When “*Music one all headsets*” is selected, music 1 (or the front panel utility jack) will be distributed to all headsets and is independent of the intercom mode switch. Therefore, even in the CREW mode, the passengers will hear Music 1, even though they will not hear the intercom or radios.

This mode allows you to use a single in-flight entertainment source aboard, and to send it everywhere, even in crew mode. The music muting will be normal, and follow the selected mode of the crew or passengers.

When select Function “B,” for the alternate function, you hear “*Music One Distribution, Crew.*” Now, music input 2 will follow the modes in Function “C.”

3.10.7 Function “C”

Function “C” allows you to configure your music to be either *independent* of the intercom mode, or to make Music 2 *dependent* on the intercom mode.

When you press Function “C,” you’ll hear, “*Alternate Music distribution.*” In this case, Music 2 will be active *only* when the intercom is in the CREW mode, and only the passengers will hear it. This distribution is similar to other brands of audio panels. It allows the passengers to have their music source come on only when they are not hearing the crew.

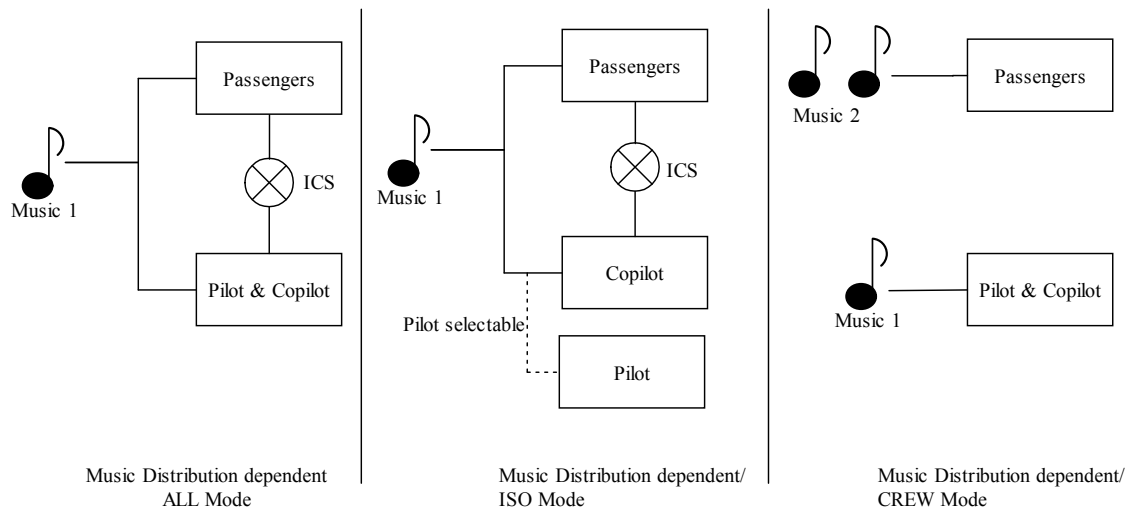

Figure 3-3 Alternate Music Distribution

Press again, and you will hear “*Standard Music Distribution.*” In this mode, Music 2 becomes active, and will always be presented to the passengers on the intercom. Music 1 is only available to the pilot and copilot. The intercom mode switch doesn't have any affect on the music distribution.

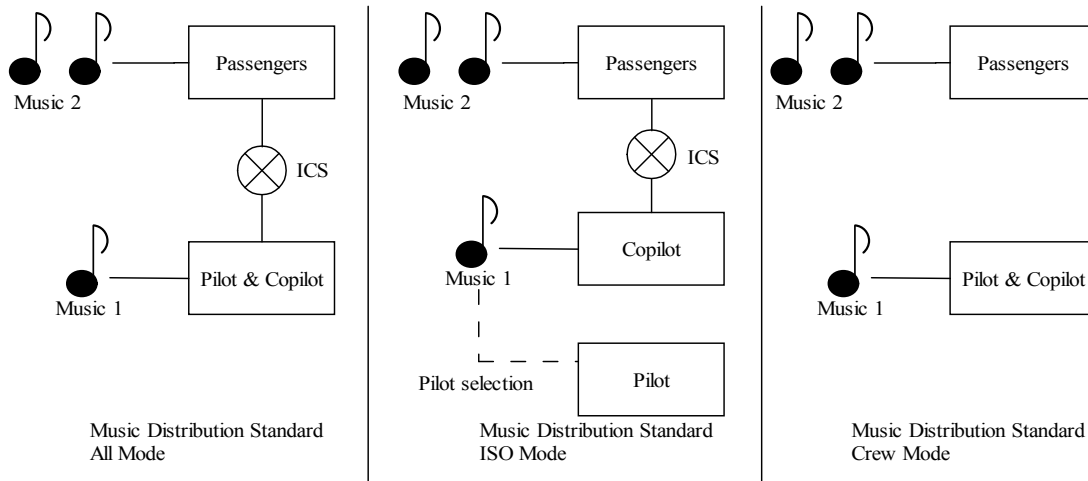

Figure 3-4 Standard Music Distribution

When the music is standard, Music 1 will always go to the pilot and copilot positions, and is never heard by the passengers. Music 2 is always heard by the passengers, and never heard by the pilot and copilot.

This mode is useful if your passengers have a different interest in entertainment or are watching a DVD, but do not want to be excluded from the intercom conversations.

3.10.8 Music 1 Volume

In general, we recommend adjusting the entertainment volume at the sources, and only using this as a master gain control. However, the Music 1 PMA8000B input can be adjusted from the front panel, if desired, by pressing the combinations of keys listed.

For serial number W04748 and above:

The Music 1 volume can be adjusted from the front panel, if desired, by pressing the combinations of keys listed.

Press **Hold Function** (Mon 1) and **Vol Down** (MUTE) (h) for more than one second to decrease music 1 MP3 volume. If the buttons are held down continuously, it will decrease the volume three steps per second.

Press **Hold Function** (Mon 1) and **Vol UP** (SPR) (i) for more than one second to increase music 1 or MP3 volume. If the buttons are held down continuously, it will increase the volume three steps per second.

Note: Since it is possible to turn the volume completely off, you may need to turn the volume up if you don't hear music when you expect to.

It will take about 10 seconds to go from minimum to maximum volume.

For serial number W04747 and below:

Hold the AUX button, and repeatedly push the Mute (volume up) or SPR (volume down) to step the volume level. There are 32 steps.

- AUX +SPR, increase volume
- AUX + Mute, decrease volume

3.11 Internal Recorder

The PMA8000B comes equipped with an internal recorder. This digital system stores the last incoming audio from the radio you have selected for transmit. It can store as many of 8 incoming messages, and up

to 60 seconds of audio. The pilot and copilot hear the playback. It is also possible to modify the unit to exclude the copilot from the playback, and annunciation playback. Contact PS Engineering, for more details. [In systems with serial number J01860 and below, only the pilot will hear the playback.]

3.11.1 Playback

Recording is automatic. To play back the last recorded message, press and hold the COM Receive pushbutton associated with the selected radio transmitter for about one (1) second. You can either wait for the message to finish playing before accessing the prior message, or cancel the current playback and step backward. To cancel the playback, press and hold the COM receive playback button for two seconds (2). The next time the button is pressed for one (1) second, the next earlier message will be heard. The playback will stop whenever there is more incoming selected com audio, and the message can be re-played from the beginning by pressing the selected Com Receive button again for 1 second.

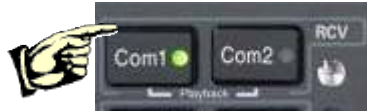

Figure 3-5 Playback Controls

Section IV – Warranty and Service

4.1 Warranty

In order for the factory warranty to be valid, the installations in a certified aircraft must be accomplished by an FAA-(or other ICAO agency) certified avionics shop and authorized PS Engineering dealer. If the unit is being installed by a non-certified individual in an experimental aircraft, a factory-made intercom harness must be used for the warranty to be valid.

PS Engineering, Inc. warrants this product to be free from defect in material and workmanship for a period of three (3) years from the date of sale. During the first **twelve (12) months** of the three-year warranty period, PS Engineering, Inc., at its option, will send a replacement unit at our expense if the unit should be determined to be defective after consultation with a factory technician. For the remaining **twenty-four (24) months** of the three-year warranty period, PS Engineering, Inc., at its option, will send a similar replacement unit at the customer's expense if the unit should be determined to be defective after consultation with an authorized PS Engineering dealer.

All transportation charges for returning the defective units are the responsibility of the purchaser. All domestic transportation charges for returning the exchange or repaired unit to the purchaser will be borne by PS Engineering, Inc. The risk of loss or damage to the product is borne by the party making the shipment, unless the purchaser requests a specific method of shipment. In this case, the purchaser assumes the risk of loss.

This warranty is not transferable. Any implied warranties expire at the expiration date of this warranty. PS Engineering SHALL NOT BE LIABLE FOR INCIDENTAL OR CONSEQUENTIAL DAMAGES. This warranty does not cover a defect that has resulted from improper handling, storage or preservation, or unreasonable use or maintenance as determined by us. This warranty is void if there is any attempt to disassemble this product without factory authorization. This warranty gives you specific legal rights, and you may also have other rights, which may vary from state to state. Some states do not allow the exclusion of limitation of incidental or consequential damages, so the above limitation or exclusions may not apply to you.

All items repaired or replaced under this warranty are warranted for the remainder of the original warranty period. PS Engineering, Inc. reserves the rights to make modifications or improvements to the product without obligation to perform like modifications or improvements to previously manufactured products.

4.2 Factory Service

The units are covered by a three-year limited warranty. See warranty information. Call PS Engineering, Inc. at (865) 988-9800 before you return any unit. This will allow the service technician to provide any other suggestions for identifying the problem and recommend possible solutions.

After discussing the problem with the technician and you obtain a Return Authorization Number, ship product to:

PS Engineering, Inc.
Attn: Service Department
9800 Martel Rd
Lenoir City, TN 37772
(865) 988-9800 FAX (865) 988-6619
Email: support@ps-engineering.com

Units that arrive without an RMA number, or telephone number for a responsible contact, will be returned un-repaired. PS Engineering is not responsible for items sent via US Mail.

Appendix A – External PTT Hook Up

Part of the installation includes the installation of PTT (Push To Talk) switches that allow the use of your aircraft radio for communications transmissions.

There are three possible configurations; you must select the case that best fits your installation.

NOTE: Only the person who presses their PTT switch will be heard over the radio.

CASE I

The PTT is built into the pilot and copilot yokes

Simply install the plugs from the headset into the aircraft headphone jacks. Then use the yoke mounted PTT to transmit. No other action is required.

CASE II

Built in PTT only on the pilot side only

This configuration requires a modified external PTT switch plugged into the copilot's mic jack. (See Details Below) When the copilot's PTT is depressed, this activates an internal relay that switches the mic audio to the aircraft radio from the pilot to the copilot.

Case III

No built in PTT switch at all.

Two built-in PTT must be installed, or two external, modified PTT switches will be required for both the pilot and copilot. Modifications to the PTT are required. (See details below)

Push To Talk Modifications

When received from the manufacturer, an after-market PTT switch opens the mic audio path to the "ring" connection of the PTT mic plug until the button is pressed. When the PTT is between the intercom and the headset, the intercom function will not work unless the PTT switch is depressed. A simple modification can be performed to allow proper intercom operation. NOTE: This mod does not alter normal operation.

Below are some examples of typical modifications. Contact the PTT manufacturer for more details if necessary.

Procedures For David Clark PTT

Unscrew the round black plastic cover from the jack.
Connect the joined black wires to the red wire.
Replace the round black plastic cover.

Procedures for Telex PT-200

Unscrew the round black plastic cover from the jack.
Cut the red wire in the middle of the wire.
Strip both ends of the insulation.
Solder the two ends to the ground lug to the PTT jack.
Replace the round black plastic cover.

Procedures for Telex PT-300

Unscrew the round black plastic cover from the plug jack.
Remove the heat shrink material from the joined black wires.
Solder these two wires to the lug that has a white wire already soldered to it.
Replace the round black plastic cover

Appendix B – PMA 8000 Installation Drawings

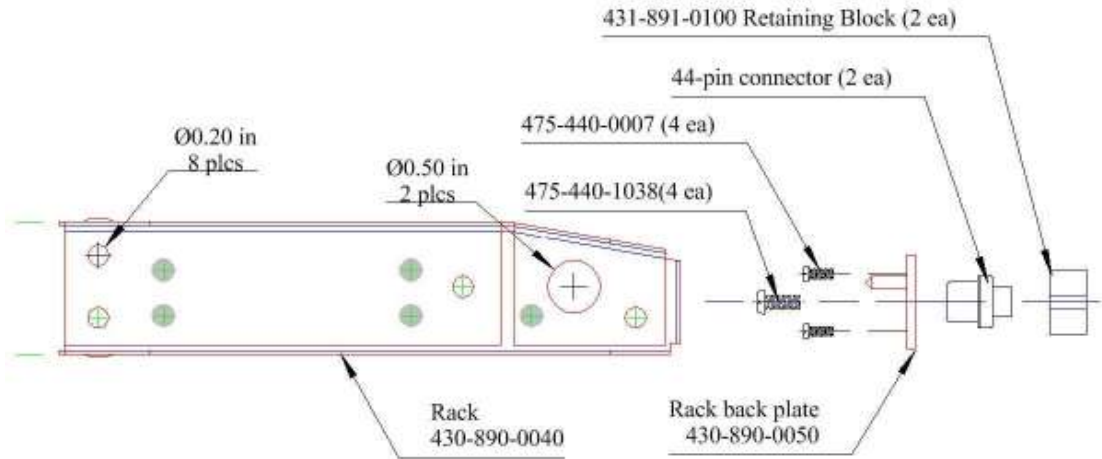

J2
Viewed from Back
J1

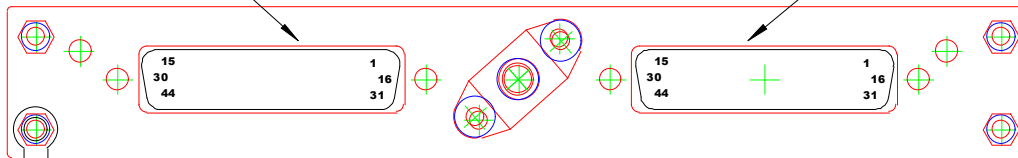

Solder Lug (mount as convenient)

Rear plate detail (not to scale)

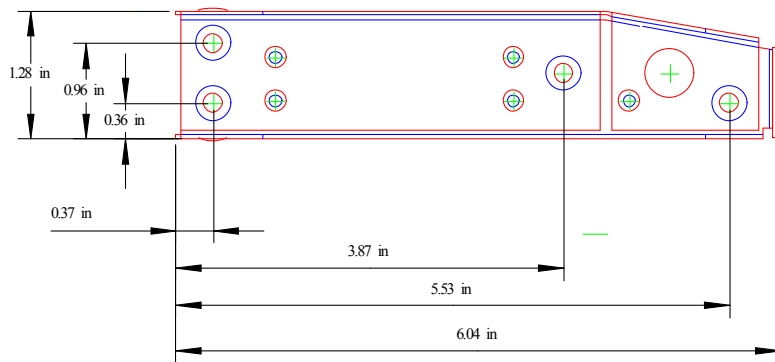
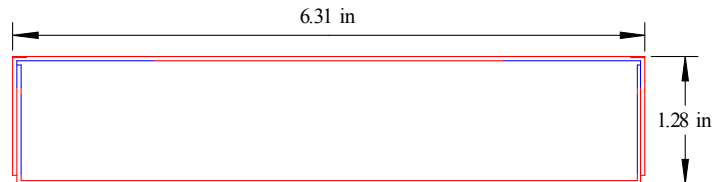

Caution: Apply steady pressure to the bezel while screwing the unit into the tray to ensure even seating of the unit and connectors.

Appendix C – J1 Connector Interconnect

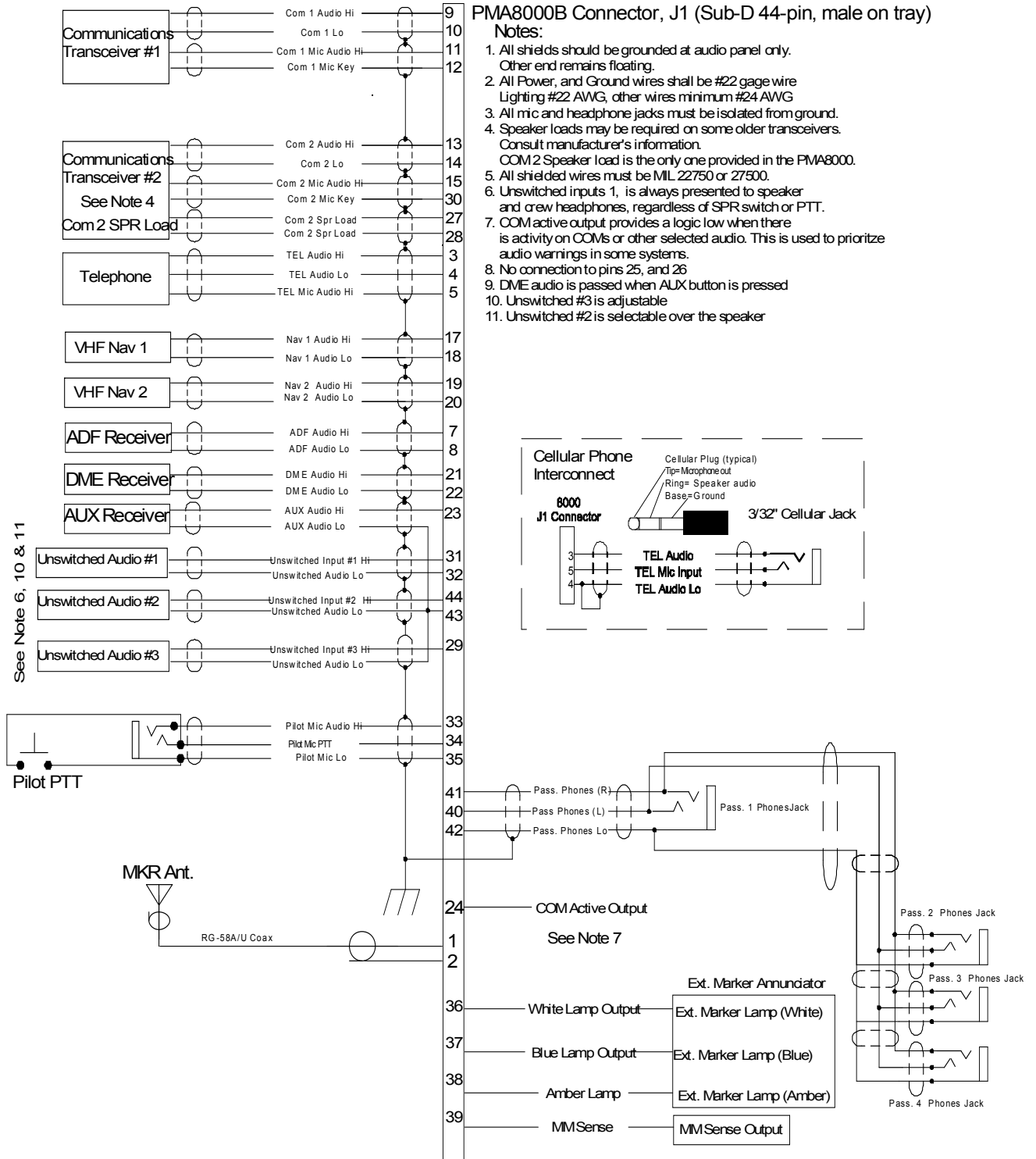

Appendix D – J2 Connector Interconnect

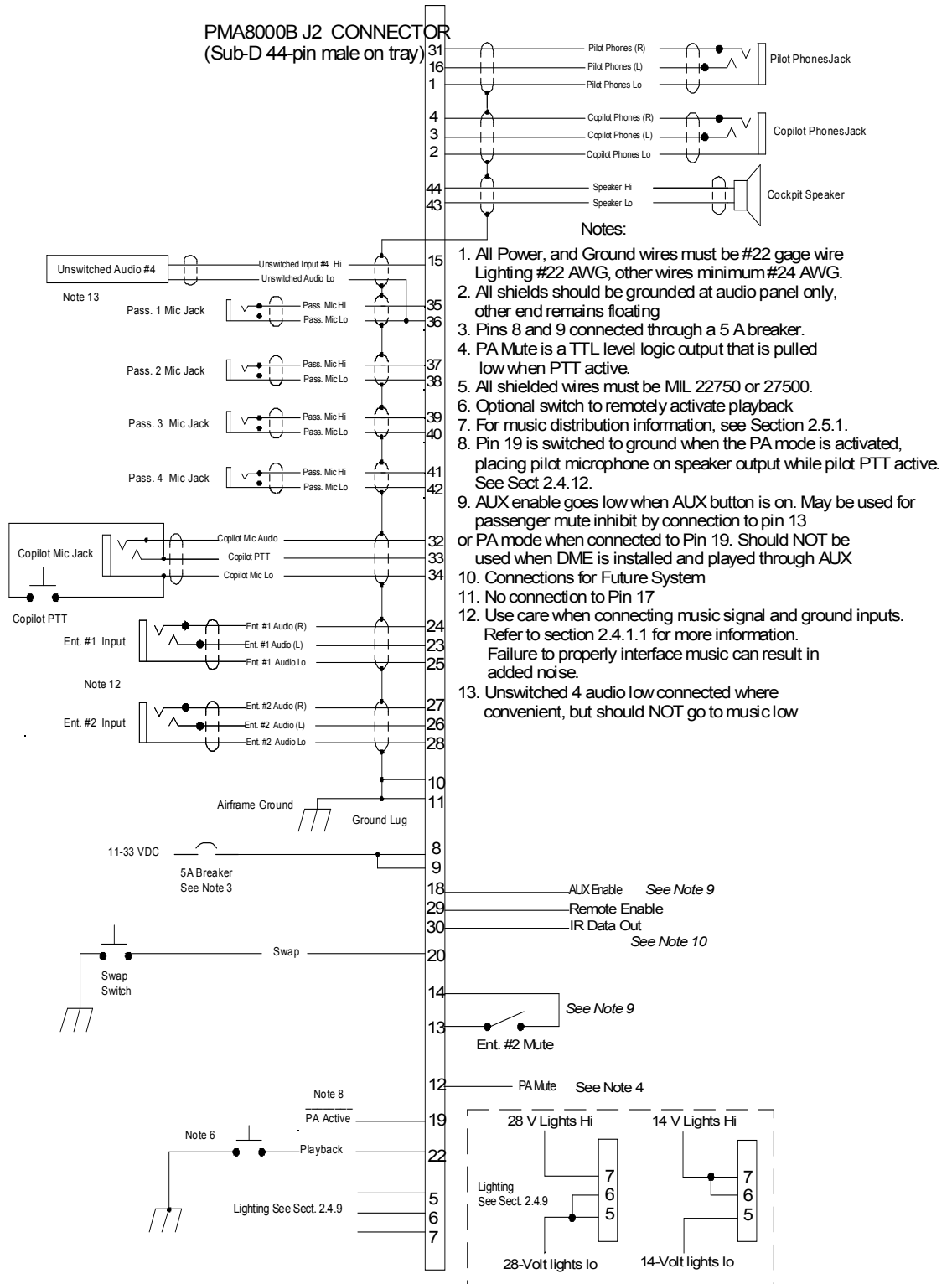

Appendix E – Instructions for FAA Form 337 and continuing airworthiness

9.1 Instructions for FAA Form 337, Audio Panels

One method of airworthiness approval is through an FAA Form 337, *Major Repair and Alteration (Airframe, Powerplant, Propeller, or Appliance)* In the case of the PMA8000B, you may use the following text as a guide.

Installed audio selector and 6-place intercom, PS Engineering PMA8000B, part number 050-890-(XXXX) in (location) at station _____. Installed per *AC43.13-2, Chapter 2, paragraph 23* (Instrument Panel Mounting). Installed per PS Engineering *Installation Operators Manual* p/n 200-890-(XXXX), revision (), dated ().

These units are FAA-Approved under TSO C50c for audio amplifiers, and/or TSO C35d for Marker Beacon Receivers, and meets appropriate environmental qualifications outlined in RTCA DO-160D as appropriate or this aircraft.

Interface to existing aircraft radios in accordance with installation manual and in compliance with practices listed in *AC43.13-2, Chapter 2*. All wires are Mil-Spec 22759 or 27500. Connection to aircraft dimmer bus is _____. Power is supplied to the unit through a 3A circuit breaker (type and part number), and total electrical load does not exceed _____% of the electrical system capacity with the PMA8000B added.

Aircraft equipment list, weights and balance amended. Compass compensation checked. A copy of the operation instructions, contained in PS Engineering document 200-080-(), revision (), dated (), is placed in the aircraft records. All work accomplished listed on Work Order _____.

9.2 Instructions for Continuing Airworthiness, Audio System

Sample ICA Checklist for PS Engineering Audio System:

Section	Item	Information
1	Introduction	Installation of audio control panel with integrated marker beacon receiver and intercommunications system.
2	Description	Installation as described in manufacturer's installation manual referenced on FAA Form 337, including interface with other avionics audio as required.
3	Controls	See installation and operator's guide referenced on FAA Form 337.
4	Servicing	None Required
5	Maintenance Instructions	On Condition, no special instructions
6	Troubleshooting	In the event of a unit problem, place the unit into "off," "fail-safe" and/or "emergency" mode. This allows pilot communications using COM 1. Follow checkout instructions in the installation manual referenced on the FAA Form 337. For a specific unit fault, contact the manufacturer at (865) 988-9800 for special instructions.
7	Removal and replacement information	<u>Removal:</u> Using a 3/32" Allen-head wrench, carefully unscrew the locking screw located in the center of the unit. While turning the wrench CCW, gently pull on the EDGES of the bezel until the unit is free from the mounting tray. <u>Installation:</u> Engage the locking screw at the back. Turn the locking screw CW, while applying slight pressure to the edges of the bezel. Do not over tighten!
8	Diagrams	Not applicable
9	Special Inspection Requirements	Not Applicable
10	Protective Treatments	Not Applicable
11	Structural Data	Not Applicable
12	Special Tools	None
13	Not Applicable	Not Applicable
14	Recommended Overhaul Periods	None
15	Airworthiness Limitations	Not Applicable
16	Revision	To be determined by installer

Appendix F – RTCA DO160D Environmental Qualification Form

Audio Selector Panel/Intercom/Marker Beacon Receiver

Part Number: 050-890-()

FAA TSO Number: C50c, C35d

Manufacturer: PS Engineering Incorporated 9800 Martel Road Lenoir City TN 37772

Conditions	Section	Conducted Tests
Temperature and Altitude	4.0	Equipment tested to CAT A1 & D1
Low Temperature	4.5.1	-55° C Survival, -15°C Low Operating (A1)
High Temperature	4.5.2	+85°C Survival, +70°C High Short Time Operating
In-flight Loss of Cooling	4.5.4	Not Applicable, no cooling required
Altitude	4.6.1	50,000' unpressurized (D1)
Decompression	4.6.2	Not Applicable
Overpressure	4.6.3	Not Applicable
Temperature variation	5.2	Equipment tested to Category C
Humidity	6.0	Equipment tested to Category A
Shock	7.0	Equipment tested to Operational test only
Operational	7.2	Equipment tested to Operational test only
Crash Safety	7.3	Equipment tested to Operational test only
Vibration	8.0	Equipment tested to Category M & N
Explosion	9.0	Category X, not tested
Waterproofness	10.0	Category X, not tested
Fluids Susceptibility	11.0	Category X, not tested
Sand and Dust	12.0	Category X, not tested
Fungus	13.0	Category X, not tested
Salt Spray	14.0	Category X, not tested
Magnetic Effect	15.0	Equipment tested to Category Z
Power input	16.0	Equipment tested to Category B
Voltage Spike	17.0	Equipment tested to Category A
Audio Frequency Susceptibility	18.0	Equipment tested to Category B
Induced Frequency Susceptibility	19.0	Equipment tested to Category A
Radio Frequency Susceptibility	20.0	Equipment tested to Category T
Radio Frequency Emission	21.0	Equipment tested to Category B
Lightning Induced Transient Susceptibility	22.0	Equipment tested to Category XXE2
Lightning Direct Effects	23.0	Category X, not tested
Icing	24.0	Category X, not tested
ESD	25.0	Category X, not tested